

5730A

Multifunction Calibrator

Getting Started Manual

LIMITED WARRANTY AND LIMITATION OF LIABILITY

Each Fluke product is warranted to be free from defects in material and workmanship under normal use and service. The warranty period is one year and begins on the date of shipment. Parts, product repairs, and services are warranted for 90 days. This warranty extends only to the original buyer or end-user customer of a Fluke authorized reseller, and does not apply to fuses, disposable batteries, or to any product which, in Fluke's opinion, has been misused, altered, neglected, contaminated, or damaged by accident or abnormal conditions of operation or handling. Fluke warrants that software will operate substantially in accordance with its functional specifications for 90 days and that it has been properly recorded on non-defective media. Fluke does not warrant that software will be error free or operate without interruption.

Fluke authorized resellers shall extend this warranty on new and unused products to end-user customers only but have no authority to extend a greater or different warranty on behalf of Fluke. Warranty support is available only if product is purchased through a Fluke authorized sales outlet or Buyer has paid the applicable international price. Fluke reserves the right to invoice Buyer for importation costs of repair/replacement parts when product purchased in one country is submitted for repair in another country.

Fluke's warranty obligation is limited, at Fluke's option, to refund of the purchase price, free of charge repair, or replacement of a defective product which is returned to a Fluke authorized service center within the warranty period.

To obtain warranty service, contact your nearest Fluke authorized service center to obtain return authorization information, then send the product to that service center, with a description of the difficulty, postage and insurance prepaid (FOB Destination). Fluke assumes no risk for damage in transit. Following warranty repair, the product will be returned to Buyer, transportation prepaid (FOB Destination). If Fluke determines that failure was caused by neglect, misuse, contamination, alteration, accident, or abnormal condition of operation or handling, including overvoltage failures caused by use outside the product's specified rating, or normal wear and tear of mechanical components, Fluke will provide an estimate of repair costs and obtain authorization before commencing the work. Following repair, the product will be returned to the Buyer transportation prepaid and the Buyer will be billed for the repair and return transportation charges (FOB Shipping Point).

THIS WARRANTY IS BUYER'S SOLE AND EXCLUSIVE REMEDY AND IS IN LIEU OF ALL OTHER WARRANTIES, EXPRESS OR IMPLIED, INCLUDING BUT NOT LIMITED TO ANY IMPLIED WARRANTY OF MERCHANTABILITY OR FITNESS FOR A PARTICULAR PURPOSE. FLUKE SHALL NOT BE LIABLE FOR ANY SPECIAL, INDIRECT, INCIDENTAL, OR CONSEQUENTIAL DAMAGES OR LOSSES, INCLUDING LOSS OF DATA, ARISING FROM ANY CAUSE OR THEORY.

Since some countries or states do not allow limitation of the term of an implied warranty, or exclusion or limitation of incidental or consequential damages, the limitations and exclusions of this warranty may not apply to every buyer. If any provision of this Warranty is held invalid or unenforceable by a court or other decision-maker of competent jurisdiction, such holding will not affect the validity or enforceability of any other provision.

Fluke Corporation
P.O. Box 9090
Everett, WA 98206-9090
U.S.A.

Fluke Europe B.V.
P.O. Box 1186
5602 BD Eindhoven
The Netherlands

OPERATOR SAFETY SUMMARY

WARNING

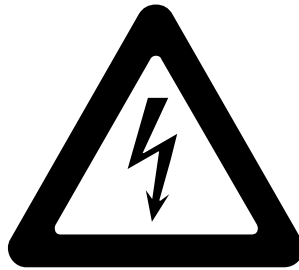

HIGH VOLTAGE

is used in the operation of this equipment

LETHAL VOLTAGE

may be present on the terminals, observe all safety precautions!

To prevent electrical shock hazard, the operator should not electrically contact the output HI or sense HI terminals or circuits connected to these terminals. During operation, lethal voltages of up to 1100 V ac or dc may be present on these terminals.

When the nature of the operation permits, keep one hand away from equipment to reduce the hazard of current flowing through vital organs of the body.

Table of Contents

Title	Page
Introduction.....	1
Safety Information	3
Symbols	4
How to Contact Fluke Calibration	5
Instruction Manuals	5
Wideband AC Voltage Module (Option 5730A/03 or 5730A/05).....	5
Auxiliary Amplifiers.....	6
5725A Amplifier	6
52120A Amplifier	7
Support Equipment and Services	7
732B Direct Voltage Reference Standard	7
732B-200 Direct Volt Maintenance Program (USA Only)	8
742A Series Resistance Standards.....	8
Wideband AC Module (Option 5730A/03 or 5730A/05) Calibration Support	8
The Components of the Calibrator.....	8
5730A Calibration.....	9
The Artifact Calibration Process	9
Establish Traceability	10
Calibration Reports.....	10
Range Adjustment	10
DC Zeros.....	10
Unpack and Inspect the Calibrator.....	11
Placement and Rack Mounting	11
Cooling Considerations.....	12
Fuse Replacement	12
Clean the Air Filter	14
Clean the Exterior	15
Connect to Mains Power.....	15
Connect a 5725A Amplifier.....	15
Connect a 52120A Amplifier.....	15
Front-Panel Features	15
Rear-Panel Features	20
General Specifications	22
Electrical Specifications	24
AC Voltage Specifications	25

Resistance Specifications	31
DC Current Specifications.....	35
AC Current Specifications.....	37
Wideband AC Voltage (Option 5730A/03 and 5730A/05) Specifications (99 % Confidence Level).....	40
52120A Specifications when Operated with the 5730A.....	41
52120A Electrical Performance Limits	42
Operated within 5730A Control Loop (all current ranges)	42
Coverage factor $k=2.58$ (99 % confidence level).....	42
Coverage factor $k=2.00$ (95 % confidence level).....	43
52120A/COIL 3 kA 25-Turn Coil	44
52120A/COIL 6 kA 50-Turn Coil	44

List of Tables

Table	Title	Page
1.	Symbols.....	4
2.	Auxiliary Amplifier Data	6
3.	Standard Equipment	11
4.	Replacement Fuses	13
5.	Front-Panel Features	16
6.	Rear-Panel Features	20

List of Figures

Figure	Title	Page
1.	Access the Fuse	13
2.	Air Filter Access	14
3.	Front-Panel Features	16
4.	Rear-Panel Features	20

Introduction

The Fluke Calibration 5730A Calibrator (the “Calibrator” or the “Product”) can calibrate a wide variety of electrical measurement instruments. The 5730A Calibrator maintains a high accuracy over a wide ambient temperature range. This accuracy lets the Calibrator test instruments in any environment, and eliminates the restrictions to calibrate only in a temperature-controlled standards laboratory. The Calibrator can calibrate precision multimeters that measure ac or dc voltage, ac or dc current, and resistance. The Calibrator also is available with a Wideband AC Voltage option which extends this workload to include RF voltmeters.

Specifications are provided at the end of this manual. The Product is a fully-programmable precision source of:

- DC voltage to 1100 V
- AC voltage to 1100 V, with output available from 10 Hz to 1.2 MHz
- AC and DC current to 2.2 A, with output available from 10 Hz to 10 kHz
- Resistance in values from 1 Ω to 100 M Ω , plus a short
- Optional wideband ac voltage from 300 μ V to 3.5 V into 50 Ω (-57 dBm to +24 dBm), 10 Hz to 30 MHz (5730A/03) or 50 MHz (5730A/05)

Features of the 5730A Calibrator include:

- Internal environmentally-controlled references that let the Calibrator maintain full performance over a wide ambient temperature range.
- Automatic meter error calculation obtained through the use of a simple output adjust knob.
- Keys that multiply and divide the output value by 10. This simplifies work on meters with calibration points at decade multiples of a fraction of full-scale.
- Programmable entry limits used to restrict the levels that can be entered into the Calibrator. This prevents access to levels that may be harmful to equipment or personnel.
- Continuous display of Calibrator specifications at the selected operation point, calibration interval, and specification confidence level.

- An auxiliary current binding post to calibrate meters with separate current inputs without the need to move cables.
- Real-time clock and calendar for date stamping reports and reminders issued to perform the dc zeros calibration procedure within the required interval.
- Offset and scaling modes that simplify linearity tests of multimeters.
- Variable phase reference signal output and phase-lock input.
- Interface for the Fluke Calibration 5725A Amplifier.
- Interface for the Fluke Calibration 52120A Amplifier.
- Standard IEEE-488 (GPIB) interface, that complies with ANSI/IEEE Standards 488.1-1987 and 488.2-1987.
- EIA/TIA-574 Standard RS-232 serial data interface for remote control of the Calibrator.
- Universal Serial Bus (USB) 2.0 high-speed interface device port for remote control of the Calibrator.
- Integrated 10/100/1000BASE-T Ethernet port for network connection remote control of the Calibrator.
- Extensive internal self-testing and diagnostics of analog and digital functions
- USB Host port to save calibration reports to a flash drive.
- Visual Connection Management output terminals illuminate to help show correct cable connection configurations.
- Soft Power - automatic selection of line voltage/frequency.
- LCD Color VGA display with touch panel overlay.
- A traceable calibration procedure for all modes and ranges that requires only 10 V, 1 Ω , and 10 k Ω external standards, with only occasional independent verification.
- Automated calibration check that provides added confidence between calibration recalls, and data that can be used to document and characterize Calibrator performance between calibration recalls.

Safety Information

A **Warning** identifies conditions and procedures that are dangerous to the user. A **Caution** identifies conditions and procedures that can cause damage to the Product or the equipment under test.

Warnings

To prevent possible electrical shock, fire, or personal injury:







- Read all safety information before you use the Product.
- Carefully read all instructions.
- Do not use the Product around explosive gas, vapor, or in damp or wet environments.
- Use this Product indoors only.
- Do not put the Product where access to the mains power cord is blocked.
- Use only the mains power cord and connector approved for the voltage and plug configuration in your country and rated for the Product.
- Replace the mains power cord if the insulation is damaged or if the insulation shows signs of wear.
- Make sure the ground conductor in the mains power cord is connected to a protective earth ground. Disruption of the protective earth could put voltage on the chassis that could cause death.
- Do not use an extension cord or adapter plug.
- Do not operate the Product with covers removed or the case open. Hazardous voltage exposure is possible.
- Do not use the Product if it operates incorrectly.
- Do not connect to live output terminals. The Product can supply voltages that can cause death. Standby mode is not sufficient to prevent electrical shock.
- Do not apply more than the rated voltage, between the terminals or between each terminal and earth ground.
- Use only cables with correct voltage ratings.

- Do not touch exposed metal on banana plugs, they can have voltages that could cause death.
- Do not touch voltages >30 V ac rms, 42 V ac peak, or 60 V dc.
- Use the Product only as specified, or the protection supplied by the Product can be compromised.
- Use only specified replacement fuses.
- Have an approved technician repair the Product.

Symbols

The symbols shown in Table 1 can be found in this manual or on the Calibrator.

Table 1. Symbols

Symbol	Definition	Symbol	Definition
	WARNING.RISK OF DANGER.		WARNING. HAZARDOUS VOLTAGE. Risk of electric shock.
	This product complies with the WEEE Directive marking requirements. The affixed label indicates that you must not discard this electrical/electronic product in domestic household waste. Product Category: With reference to the equipment types in the WEEE Directive Annex I, this product is classed as category 9 "Monitoring and Control Instrumentation" product. Do not dispose of this product as unsorted municipal waste.		Conforms to European Union directives.
	Certified by CSA Group to North American safety standards.		Conforms to relevant Australian EMC standards.
	Conforms to relevant South Korean EMC Standards.		

How to Contact Fluke Calibration

To contact Fluke Calibration, call one of the following telephone numbers:

- Technical Support USA: 1-877-355-3225
- Calibration/Repair USA: 1-877-355-3225
- Canada: 1-800-36-FLUKE (1-800-363-5853)
- Europe: +31-40-2675-200
- Japan: +81-3-6714-3114
- Singapore: +65-6799-5566
- China: +86-400-810-3435
- Brazil: +55-11-3759-7600
- Anywhere in the world: +1-425-446-6110

To see product information or download manuals and the latest manual supplements, visit Fluke Calibration's website at www.flukecal.com.

To register your product, visit <http://flukecal.com/register-product>.

Instruction Manuals

The 5730A Calibrator ships with:

- *5730A Getting Started*
- *5730A Operators Manual* (provided on CD-ROM or a printed copy is available for purchase through the Fluke Calibration Service Department)

To order, refer to the Fluke Calibration Catalog or contact a Fluke Calibration sales representative. See "How to Contact Fluke Calibration".

Wideband AC Voltage Module (Option 5730A/03 or 5730A/05)

The Wideband AC Voltage Module (Option 5730A/03 or 5730A/05) can be installed in the 5730A Calibrator. The module is a high-accuracy, low-noise, extremely flat ac voltage source to calibrate RF voltmeters, with a frequency range of 10 Hz to 30 MHz (5730A/03) or 50 MHz (5730A/05). Output is in seven ranges from 300 μ V (-57 dBm) to 3.5 V (+24 dBm) through a Type-N coaxial connector into a 50 Ω load. The output level is selected in volts or dBm through either the front panel controls or under remote control.

The wideband module also functions with the Calibrator output adjust controls that display the error of a wideband meter in either percentage of output or in decibels.

Included with the wideband module is a Type-N output cable, a 50 Ω terminator, an N(f) to BNC(m) adapter, and a BNC(f) to double banana plug adapter. The wideband module is calibrated to the end of its standard-equipment output cable.

Auxiliary Amplifiers

The Fluke Calibration Model 5725A and 52120A amplifiers are available to extend the high voltage performance and current range of the 5730A Calibrator.

Interface connectors on the Calibrator rear panel accept cables to directly operate a 5725A and/or 52120A. Multiple amplifiers can be connected to the Calibrator at the same time, but only one output can be active at a time. Once the amplifiers are connected and configured in the Product Setup Menu, amplifier operation is controlled by the Calibrator.

A maximum of three 52120As can be connected to provide a maximum of 360 A rms ac or 300 A dc current when their outputs are connected in parallel.

See Chapter 4 of the Operators Manual for instructions to operate both amplifiers. The general specifications at the end of this manual include specifications to operate the 5730A Calibrator with both amplifiers. For other amplifier specifications, refer to their instruction manuals. Table 2 summarizes the extended capabilities offered by the 5725A and 52120A. Brief descriptions of the extended capabilities follow.

Table 2. Auxiliary Amplifier Data

Model	Mode	Range
5725A Amplifier	AC Volts	20 V rms to 1100 V rms up to 70 mA, 40 Hz to 30 kHz (50 mA < 5 kHz) 220 V rms to 750 V rms up to 70 mA, 30 kHz to 100 kHz
	DC Amps	0 A to ± 11 A
	AC Amps	1 A rms to 11 A rms, 40 Hz to 10 kHz
52120A Transconductance Amplifier ^[1]	DC Amps	0 A to ± 100 A
	AC Amps	0.2 A rms to 120 A rms, 10 Hz to 10 kHz
[1] Up to three 52120As may be connected, providing a total current of up to 300 A dc or 360 A rms.		

5725A Amplifier

The Fluke Calibration 5725A Amplifier is an external unit that operates under calibrator control. It extends ac voltage drive capabilities and both ac and dc current output range. The amplifier adds these capabilities to the 1100 V ac range of the 5730A Calibrator with no compromise in accuracy:

- Frequency limits at higher voltage increase to 100 kHz at 750 V, 30 kHz at 1100 V.
- Load limit increases to 70 mA for frequencies above 5 kHz.
- Capacitive drive increases to 1000 pF, subject to the maximum output current.

A separate set of binding posts on the front panel of the 5725A supplies extended-range ac and dc current outputs. Since most meters have a separate input terminal for the high-current ranges, this eliminates the need to change cables during a procedure. The 5725A can also be configured to source all current (both standard calibrator-generated current and its own current) through the 5725A binding posts.

52120A Amplifier

The Fluke Calibration 52120A Transconductance Amplifier is an external unit that operates under calibrator control to extend the ac and dc current output range of the 5730A Calibrator. A maximum of three 52120A amplifiers can be connected, as much as tripling the current output available. The 52120A amplifier can:

- Accept full scale dc or ac inputs of 2 volts or 200 mA from any calibrator, signal generator or power supply
- Deliver proportional output current in ranges of 2 A, 20 A or 120 A at frequencies to 10 kHz
- Offer enhanced accuracy to 140 ppm when used in closed-loop mode with a 6105A Electrical Power Standard
- Operate in parallel with one or two other 52120As to deliver 240 A or 360 A
- Source current with compliance voltage of 4.5 V rms or 6.4 V peak
- Drive inductive loads to 1 mH
- Drive optional current coils to deliver test currents of 3000 A or 6000 A

Support Equipment and Services

Fluke Calibration supports calibration requirements with precision, high-quality equipment and a wide range of services. Depending on the calibration needs, location, and capabilities, the 5730A Calibrator can be supported independently or with Fluke Calibration services for part, or all support needs. The subsequent paragraphs describe the support equipment and services offered by Fluke Calibration for the Calibrator. For specifications and ordering instructions for this support equipment and other Fluke Calibration instruments, refer to the Fluke Calibration catalog, or contact a representative at a Fluke Calibration Sales and Service Center. See “How to Contact Fluke Calibration”.

732B Direct Voltage Reference Standard

The Fluke Calibration 732B is a rugged, easily transported solid state direct voltage reference standard with a highly predictable 10 V output. The 732B can be short-circuited, even for extended periods of time, without damage or loss of stability. It maintains full specified stability over a temperature span of 18 °C to 28 °C.

The 5730A Calibrator uses a 10 V reference standard such as the Fluke Calibration 732B in its semi-automated calibration procedure to establish external voltage traceability. Chapter 7 of the Operators Manual describes this procedure.

732B-200 Direct Volt Maintenance Program (USA Only)

The Fluke Calibration 732B-200 Direct Volt Maintenance Program provides laboratories with NIST-traceable 10 V calibration uncertainty as low as 0.6 parts per million (ppm).

The program maintains the 732B that is kept in the laboratory. To do this:

1. Fluke Calibration sends a calibrated Fluke Calibration-owned 732B standard, together with all-necessary connection cables and instructions for comparison with a customer 10 V reference standard.
2. The customer takes a series of readings over five days, and returns the results to the Fluke Calibration Standards Laboratory.
3. The Fluke Calibration Standards Laboratory assigns a value to the customer 10 V standard relative to the NIST legal volt and sends a report of calibration.

742A Series Resistance Standards

The 5730A Calibrator uses 1 Ω and 10 k Ω resistor standards such as the 742A Series in its semi-automated calibration procedure to establish external traceability of resistance and current. Chapter 7 of the Operators Manual describes this procedure.

The 742A Resistance Standards are constructed of arrays of Fluke Calibration wirewound precision resistors and are ideally suited as support standards for the Calibrator. Stability of the resistance transfer standards and their temperature coefficients make them ideal for easy transport to the Calibrator work environment.

Wideband AC Module (Option 5730A/03 or 5730A/05) Calibration Support

The Wideband AC Module (Option 5730A/03 or 5730A/05) requires two kinds of calibration: gain and flatness. Gain constants are checked and recalibrated as part of the normal 5730A Calibrator semi-automated calibration process.

Since frequency flatness is determined by such stable parameters as circuit geometry and dielectric constants, flatness of the Wideband AC Module has excellent long-term stability. This stability gives the Wideband AC Module a two-year calibration cycle for flatness calibration. Flatness calibration is required only infrequently, and can be done when the Calibrator is returned to a standards laboratory for periodic verification. Chapter 7 of the Operators Manual contains the wideband gain and flatness calibration procedures.

The Components of the Calibrator

The 5730A Calibrator is configured internally as an automated calibration system, with process controls and consistent procedures. Internal microprocessors control all functions and monitor performance with the use of a switching matrix to route signals between modules. Complete automatic internal diagnostics, both analog and digital, confirm operational integrity.

Reference amplifiers maintain dc accuracy and stability. Reference amplifiers have the lowest noise and best stability. Reference amplifiers in the Calibrator go through special selection processes that include long-term aging to ensure high reliability and performance well within specifications.

The Calibrator achieves its exceptional ac voltage accuracy by the use of a patented Fluke Calibration rms sensor to make real-time ac/dc comparison measurements. The Fluke Calibration rms sensor is similar in principle to the traditional thermal voltage converter, but has a shorter time constant, virtually no reversal error, higher signal-to-noise ratio, and better frequency response. In the Calibrator, one Fluke Calibration rms sensor serves as an ac/dc or ac/ac transfer standard to develop gain and flatness correction constants during calibration. The second Fluke Calibration rms sensor continuously monitors and corrects output voltage during operation.

A patented 26-bit digital-to-analog converter (DAC) lets the Calibrator precisely vary its output. This is a pulse-width-modulated DAC with linearity typically better than 0.2 ppm of full scale. As with the other internal functions, the linearity of the DAC is automatically checked during calibration and analog diagnostics.

5730A Calibration

The 5730A Calibrator makes use of internal check standards and measurement systems. As a result, it can be completely calibrated in place to full specifications with a small number of convenient, portable, environmentally-tolerant standards available from Fluke Calibration. This procedure is traceable to military standard requirements.

When manufactured, each Product is calibrated and thoroughly verified with process metrology and calibration standards traceable to the International System of units (SI) through well-recognized national metrology institutes. A certificate of calibration that is accredited to ISO 17025 is included.

The calibration verification procedure is recommended every 2 years or as required by established policies. This procedure involves no adjustments. It ensures internal processes are in control, and establishes parallel external traceability paths for internal functions such as ac transfers that are never adjusted or corrected.

The Artifact Calibration Process

Calibration requires only three external standards or artifacts: 10 V, 1 Ω , and 10 k Ω . Environmentally-controlled internal check standards provide the primary reference points. A stored table of calibration constants defines additional reference points for controlling the output. Traceable calibration and adjustment to the specified level of performance is accomplished in a semi-automated process that revises this table.

When finished with artifact calibration, but before the new constants are saved, the 5730A Calibrator presents the proposed adjustments as +/- ppm of range and percentage change in specification for each range and function. A list of changes can be sent to the computer through the serial port, USB device port, Ethernet port, or the IEEE-488 port using the remote command: CAL_RPT? CHECK. Also on completion of calibration, the Calibrator shows the largest proposed change.

Calibration can be completed as far as deriving and printing the proposed adjustments without entering the calibration protection passcode. To save the changes in non-volatile memory to adjust future outputs from the Calibrator, the passcode must be entered from the front panel or with a remote command. The passcode entry menu is shown on the display when necessary.

Establish Traceability

Traceability to national standards is established as follows:

- Except for the internal ac/dc transfer standard, the internal check standards are directly calibrated by traceable external standards every time the Calibrator is calibrated.
- The internal ac/dc transfer standard is never adjusted, so its traceability is not disturbed by calibration. Infrequent verification is done in the traditional way, by comparing selected ac voltage outputs with an external dc voltage standard through an external ac/dc transfer standard. Fluke Calibration recommends this to be done every two years or as determined by the policy of your organization.
- Infrequent independent verification is also done on stable parameters, such as frequency flatness, determined more by circuit geometry and dielectric constants than time.

Calibration Reports

The 5730A Calibrator stores two sets of calibration constants: the set currently in use and the old set from the previous calibration. This gives the Calibrator the ability at any time to produce a calibration report of the differences between the present settings and the settings that were in effect before the last calibration. The report shows shifts in various output values from before to after the most recent calibration for each range and function in +/- ppm of range and in percentage of specification limit. The report can be saved to a USB drive or retrieve it from a host computer through either the RS-232, USB device port, Ethernet port, or IEEE-488 interface.

Range Adjustment

After calibration, further fine adjustments can be made to each range. Range adjustments are optional and they are not necessary to meet total uncertainty specifications. However, they can help to align the Calibrator closer to in-house standards.

Before range calibration is done, first do the Artifact Calibration as described later in this manual. This is to calibrate the ranges that will not be adjusted. It also performs an initial adjustment for each range, and supplies flatness corrections for ac functions.

DC Zeros

DC Zeros is a quick, automatic process that corrects offset errors that increase with time on several output ranges. If a 5725A Amplifier is attached, it also zeros the 11 A dc range. This process takes approximately 2 ½ minutes (plus an additional 30 seconds for the 5725A).

To execute dc zeros, from the normal operation screen:

1. Touch **Setup Menu** to show the Setup Menu. See the “Setup Menu” section of Chapter 4 in the Operators Manual.
2. Touch the **Calibration** menu.
3. Touch **Run DC Zero** to start the dc zeros routine. The status of the dc zero calibration is shown as the Calibrator progresses through a series of steps. When completed, the Calibrator shows “Calibration complete”.

Note

If the Calibrator is not warmed up, the display prompts to continue or cancel the DC Zeros function.

4. Touch **Close** to proceed with Calibrator use.

Unpack and Inspect the Calibrator

The 5730A Calibrator ships in a container that prevents shipping damage. Inspect the Calibrator carefully for damage, and immediately report any damage to the shipper. Instructions for inspection and claims are included in the shipping container.

When the Calibrator is unpacked, check for all the standard equipment listed in Table 3 and check the shipping order for additional items ordered.

Table 3. Standard Equipment

Item	Model or Part Number
Calibrator	5730A
Mains Power Cord	See Table 2-2 and Figure 2-1 in the Operators Manual.
5730A Getting Started	4290571
5730A Manual CD (Containing the Operators Manual)	4290580
Certificate of Calibration	No part number

Placement and Rack Mounting

Put the 5730A Calibrator on top of a bench or mount in a standard-width, 24-inch (61-cm) deep equipment rack. For bench-top use, the Calibrator has non-slipping, non-marring feet. To mount the Calibrator in an equipment rack, use the Rack Mount Kit (Model Y5737) or the Rack Ear Kit (Model Y5738). Instructions are included with the kit.

⚠️⚠️ Warnings

To prevent possible electrical shock, fire, or personal injury, do not restrict access to the Calibrator mains power cord. The mains power cord is the mains disconnecting device. If access to the power cord is inhibited by rack mounting, a properly-rated accessible mains disconnecting switch must be provided within reach as part of the installation.

Cooling Considerations

Caution

Damage caused by overheating can occur if the area around the air intake is restricted, the intake air is too warm, or the air filter becomes clogged.

Adhere to these rules to lengthen the life of the 5730A Calibrator and enhance its performance:

- The area around the air filter must be at least 3 inches from nearby walls or rack enclosures.
- The exhaust perforations on the sides of the Calibrator must be clear of obstructions.
- The air that enters the Calibrator must be room temperature. Make sure that exhaust from another instrument is not directed into the fan inlet.
- Clean the air filter every 30 days or more frequently if the Calibrator is operated in a dusty environment. Instructions for cleaning the air filter are later in this manual.

Fuse Replacement

Access the fuse from the rear panel. The fuse rating label below the fuse holder shows the correct replacement fuse ratings for each operating voltage.

Warning

To prevent possible electrical shock, fire, or personal injury:

- **Turn the Product off and remove the mains power cord. Stop for two minutes to let the power assemblies discharge before you open the fuse door.**
- **Replace a blown fuse with exact replacement only for continued protection against arc flash.**
- **Use only specified replacement fuses, see Table 4.**

To access the fuse, refer to Figure 1:

1. Disconnect the mains power cord.
2. With a standard screwdriver, release the fuse holder door.
3. Pull out the fuse holder.
4. If necessary, replace the fuse.
5. Reinsert the fuse holder.
6. Close the fuse holder door.

Table 4. Replacement Fuses

Line Voltage Range	Fuse Description	Fluke Part Number
⚠ 100 V – 120 V	T 3 A 250 V	109280
⚠ 220 V – 240 V	T 1.5 A 250 V	109231

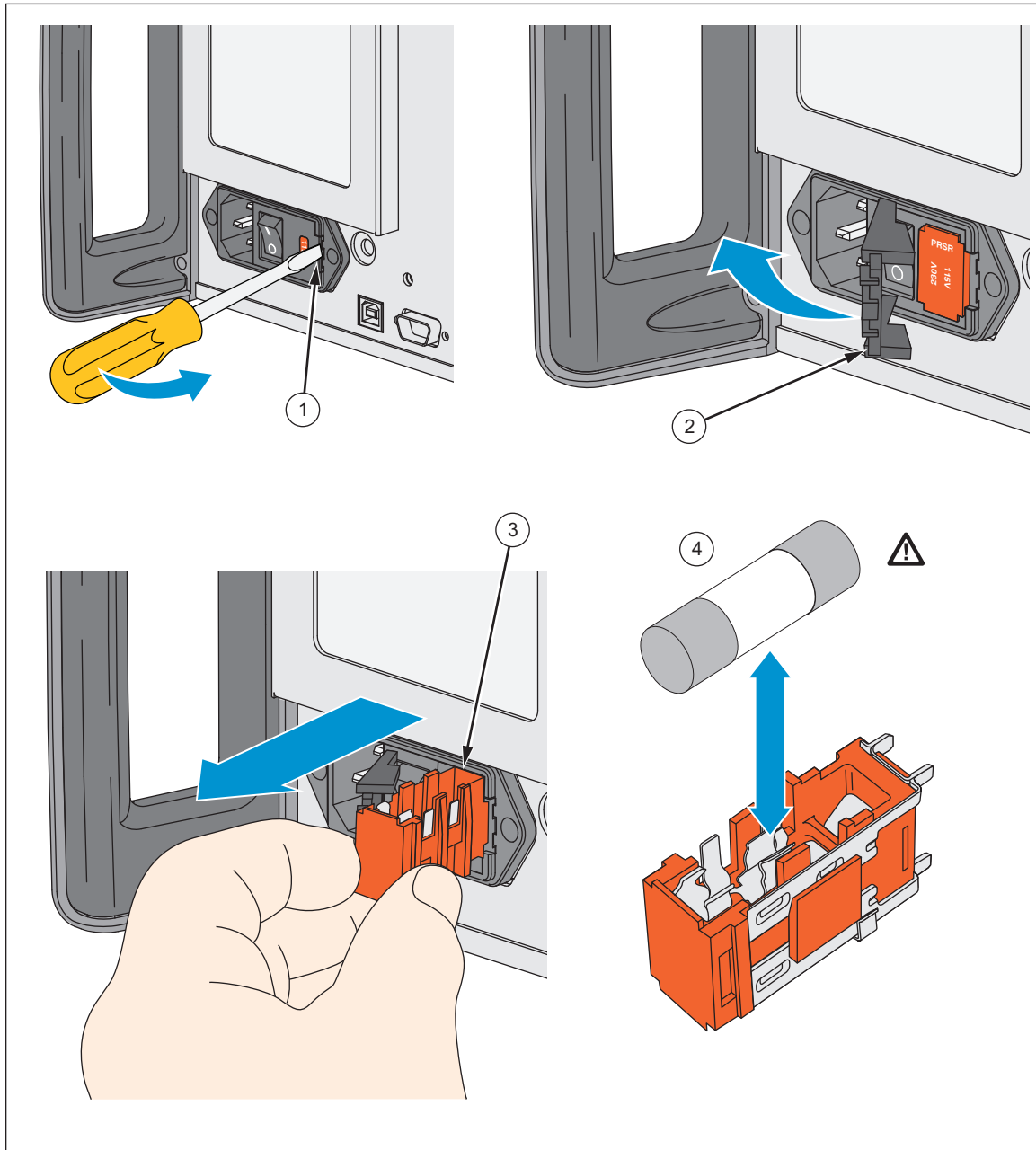

Figure 1. Access the Fuse

hhp003.eps

Clean the Air Filter

⚠ Caution

Damage caused by overheating can occur if the area around the fan is restricted, the intake air is too warm, or the air filter becomes clogged.

To prevent Product damage, make sure that the filter is completely dry before reinstallation.

The air filter must be removed and cleaned at least every 30 days, or more frequently if the Calibrator is operated in a dusty environment. The air filter is accessible from the rear panel of the Calibrator.

To clean the air filter, refer to Figure 2:

1. Disconnect line power.
2. Unscrew the knurled screw at the top of the air filter and pull the filter retainer downwards (it is hinged at the bottom) to remove the filter.
3. Clean the filter by washing it in soapy water. Rinse and dry it thoroughly.
4. Reinstall the filter and the knurled screw.

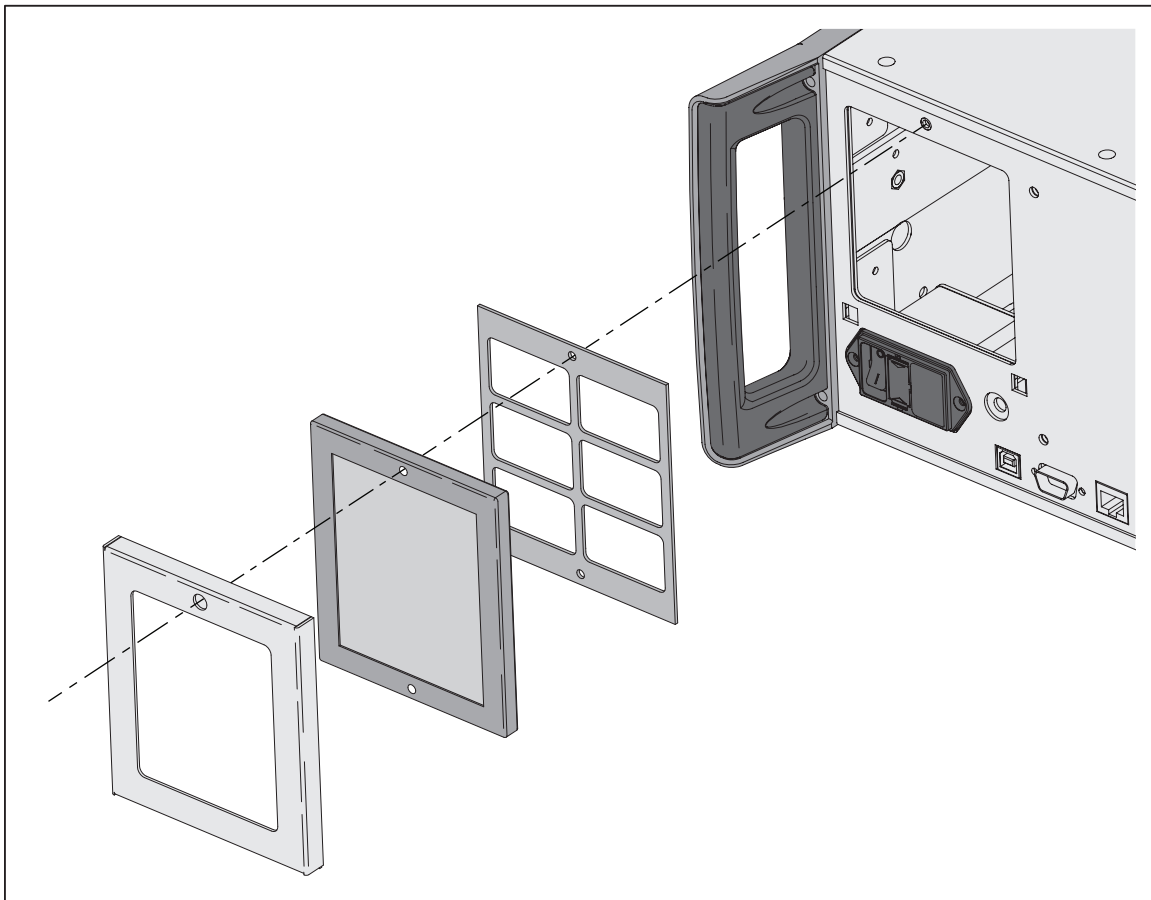

Figure 2. Air Filter Access

hhp026.eps

Clean the Exterior

To keep the 5730A Calibrator looking new, clean the case, front panel keys, and display with a soft cloth slightly dampened with either water or a non-abrasive mild cleaning solution that is not harmful to plastics.

⚠ Caution

Do not use aromatic hydrocarbons or chlorinated solvents for cleaning. They can damage the plastic materials used in the Product.

Connect to Mains Power

⚠⚠ Warning

To prevent shock hazard, connect the factory-supplied three-conductor mains power cord to a properly-grounded power outlet. Do not use a two-conductor adapter or extension cord, as it will break the protective ground connection. If a two-conductor mains power cord must be used, a protective grounding wire must be connected between the ground terminal and earth ground before you connect the mains power cord or operate the Product.

Connect a 5725A Amplifier

The 5730A Calibrator provides an interface connector for the Fluke 5725A Amplifier. Designate the active amplifier for voltage and current boost in the Setup Menu, as detailed in Chapter 4 of the Operators Manual. Refer to the *5725A Instruction Manual* for the installation procedure.

Connect a 52120A Amplifier

The 5730A Calibrator provides an interface connector for the Fluke 52120A Transconductance Amplifier. Designate the active amplifier for current boost in a Setup Menu, as detailed in Chapter 4 of the Operators Manual. Refer to the *52120A Users Manual* for the installation procedure.

Front-Panel Features

Front-panel features (including all controls, displays, indicators, and terminals) are shown in Figure 3. Each front-panel feature is briefly described in Table 5.

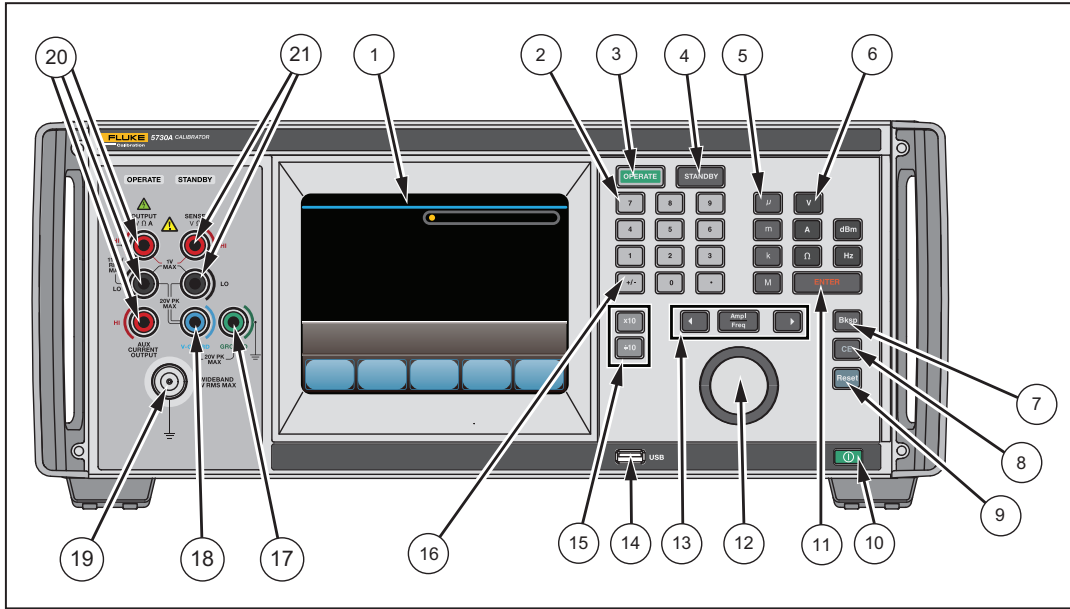

Figure 3. Front-Panel Features

hhp006.eps

Table 5. Front-Panel Features

Item	Description
①	The color touch-sensitive display shows the output amplitude, frequency, and other active conditions and messages. The display provides controls not available with the keys alone. The Calibrator interface is made up of multiple menus, described in Chapter 4 of the Operators Manual.
②	Numbered keys to enter the output amplitude, frequency, and other data such as the time and date. To enter a value, push the digits of the output value, a multiplier key (if necessary), and an output function key. Then push ENTER . For example, for an output of 20 mV, push 2 0 m V ENTER .
③ OPERATE	OPERATE activates the programmed output.

Table 5. Front-Panel Features (cont.)

Item	Description
<p>④ STANDBY</p>	<p>STANDBY deactivates the programmed output. The output automatically changes to STANDBY if:</p> <ul style="list-style-type: none"> • Reset is pushed • The output voltage is changed from <22 V to >22 V • The output location changes • The output function changes. An exception to this is that the output stays operational when functions are changed between ac and dc voltage.
<p>⑤</p>	<p>Multiplier keys to select output value multipliers. For example, if 3 3 m V ENTER is entered, the Calibrator output value is 33 mV. The multiplier keys are:</p> <p>μ micro (10^{-6})</p> <p>m milli (10^{-3})</p> <p>k kilo (10^3)</p> <p>M mega (10^6)</p>
<p>⑥</p>	<p>Output function keys. The output functions are:</p> <p>dBm Decibels relative to 1 mW</p> <p>V Voltage</p> <p>A Current</p> <p>Ω Resistance</p> <p>Hz Frequency</p> <p>When Hz is entered, the Calibrator automatically switches to ac. When a new signed (+ or -) output value is entered without specifying Hz, the Calibrator automatically switches back to dc.</p>
<p>⑦ Bksp</p>	<p>Backspace (Bksp) key. As a new output value is entered, use this key to delete the last key entry.</p>
<p>⑧ CE</p>	<p>The CE (Clear Entry) key clears a value entry in progress.</p>
<p>⑨ Reset</p>	<p>The Reset key returns the Calibrator to its initial power-up state.</p>
<p>⑩</p>	<p>Power button. Push the lighted power button to turn on or off the Calibrator.</p>
<p>⑪ ENTER</p>	<p>The ENTER key changes the output value just keyed in with the numerical, multiplier, and output function keys explained above.</p>

Table 5. Front-Panel Features (cont.)













Item	Description
⑫	Turn the Edit knob to the right to increase the output value of the active-edit digit. Turn the Edit knob to the left to decrease the output value of the active-edit digit.
⑬ 	Error mode / edit keys  moves the active-edit digit one decimal place to the left.  switches the active-edit field between the amplitude and frequency.  moves the active-edit digit one decimal place to the right.
⑭	Front USB port. Calibration report data can be saved to a flash drive inserted into this port. The Calibration report process is explained in Chapter 7 of the Operators Manual.
⑮ 	Multiplier keys  - multiplies the present output by 10.  - divides the present output by 10.
⑯ 	Invert output key. If the output function is dc voltage, current, ac voltage entered in dBm, or a wideband output entered in dBm, push   to toggle the polarity of the output. If the output function is ac voltage or current, push   to change the output to dc.
⑰ GROUND Binding Post	If the Calibrator is the location of the ground reference point in a system, the GROUND binding post can be used to connect other instruments to earth ground. The chassis is normally connected to earth ground through the three-conductor line cord instead of through the earth ground binding post. Refer to "Cable Connection Instructions" in Chapter 4 of the Operators Manual for details. Included with the Calibrator is a brass strap that connects GROUND to V GUARD.
⑱ V GUARD Binding Post ^[1]	The V GUARD binding post provides an external connection point for the internal voltage guard. For a UUT with floating (ungrounded) inputs, the V GUARD should be connected to LO internally (External Guard OFF). For a UUT with a grounded input, the V GUARD must be externally connected to the grounded UUT input (External Guard on). The maximum allowable potential between the V GUARD connector and chassis ground is 20 V peak. Refer to "When to use the External Voltage Guard" and "Cable Connection Instructions" in Chapter 4 of the Operators Manual for details.
⑲ WIDEBAND Connector ^[1]	The WIDEBAND connector is a Type "N" connector that provides a connection point for output from the Option 5730A/03 or 5730A/05 Wideband AC Module. Wideband output specifications are stated for output levels present at the end of its 3-foot 50 Ω coaxial cable terminated into a 50 Ω purely resistive load. The connector shell is connected to chassis ground. Refer to Chapter 4 of the Operators Manual for connecting and operating instructions for the wideband module.

Table 5. Front-Panel Features (cont.)

Item	Description
<p>(20) OUTPUT Binding Posts^[1]</p>	<p>Connection points for ac and dc current and voltage output, and resistance. The function of each OUTPUT binding post is defined below:</p> <p>LO The common binding post for all output functions including 5725A amplified voltage output, but not Option 5730A/03 or 5730A/05 Wideband AC or other auxiliary amplifier output.</p> <p>HI The active binding post for all output functions including 5725A amplified voltage output, but not Option 5730A/03 or 5730A/05 Wideband AC or other auxiliary amplifier output.</p> <p>AUX CURRENT OUTPUT An optional active binding post for current. It is convenient to use the AUX CURRENT OUTPUT binding post when calibrating a UUT with a separate current input terminal. Refer to "Connect the Calibrator to the UUT" in Chapter 4 of the Operators Manual for instructions for use of this binding post.</p>
<p>(21) SENSE Binding Posts^[1]</p>	<p>The SENSE binding post is used with resistance and voltage functions for sensing at the UUT after the external sense has been selected by the touch of External Sense or by remote command.</p> <p>External sensing should be used in the dc voltage function when the UUT draws enough current to produce a significant voltage drop in the cables, and in the resistance function when the UUT has a four-wire ohms input and the Calibrator is set to 100 kΩ or less. External sensing can also be used in the two-wire ohms function to allow the two-wire compensation circuitry to the UUT terminals. Refer to "When to use External Sensing," "Four-Wire Vs. Two-Wire Resistance Connections," and "Cable Connection Instructions" in Chapter 4 of the Operators Manual for external sensing instructions and illustrations of SENSE connections.</p>
<p>[1] Visual Connection Management Terminals. The appropriate terminals light up in green when ENTER is pushed, whether in STANDBY or OPERATE. The terminals offer visual guidance for cable connections for specific functions, protect the user by indicating which terminals are active, and protecting the calibrator from damage from incorrect connections.</p>	

Rear-Panel Features

Rear-panel features (including all terminals, sockets, and connectors) are shown in Figure 4. Each rear-panel feature is briefly described in Table 6.

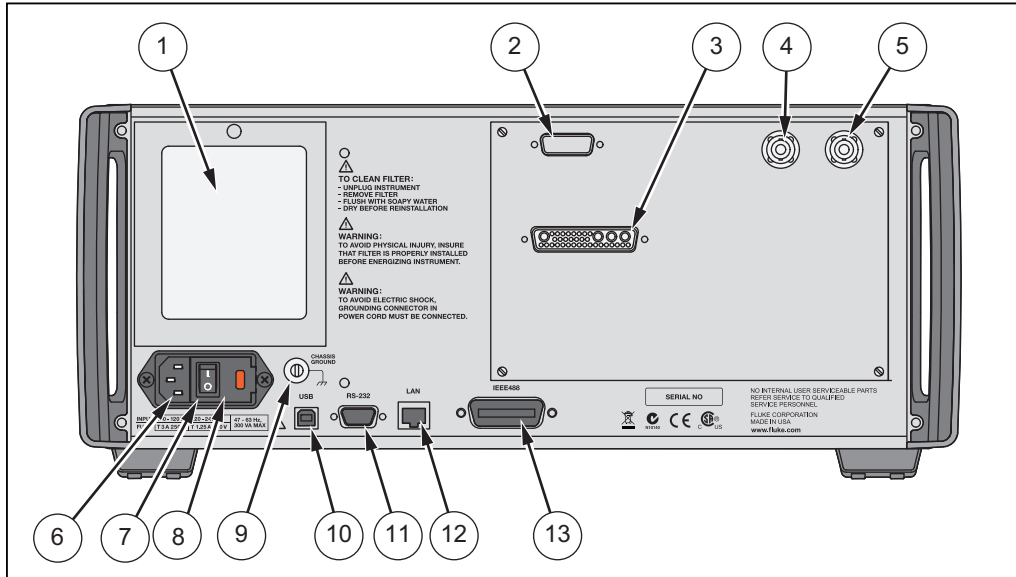

hhp009.eps

Figure 4. Rear-Panel Features

Table 6. Rear-Panel Features

Item	Description
① Fan Filter	The filter covers the air intake to keep dust and debris out of chassis. Fans inside the Calibrator provide a constant cooling air flow throughout the chassis. Circuitry inside the Calibrator monitors correct operation of the internal fans.
② 52120A Transconductance Amplifier Connector	Provides the analog and digital interface for the Fluke 52120A Transconductance Amplifier. After the 52120A is connected to the 52120A AMPLIFIER connector, control the 52120A from the Calibrator front panel or by remote commands. Refer to "Auxiliary Amplifier Use" in Chapter 4 of the Operators Manual for details.
③ 5725A Amplifier Connector	Provides the analog and digital interface for the Fluke 5725A Amplifier. After the 5725A is connected to the 5725A AMPLIFIER connector, control the 5725A from the Calibrator front panel or by remote commands. Refer to "Auxiliary Amplifier Use" in Chapter 4 of the Operators Manual for details.
④ VARIABLE PHASE OUT BNC Connector	Provides access to a variable-phase nominal 2.5 V rms sine-wave signal, intended for a 3 kΩ load. The phase of this signal can be adjusted with the arrow keys and rotary knob (or by remote commands) to lead or lag the main Calibrator output signal by up to 180 degrees. The connector shell is not connected directly to chassis ground. It is connected internally to the OUTPUT LO binding post. The maximum allowable potential between the connector shell and chassis ground is 20 V peak. Refer to "Variable Phase Output" in Chapter 4 of the Operators Manual for details.

Table 6. Rear-Panel Features (cont.)

Item	Description
<p>⑤ PHASE LOCK IN BNC Connector</p>	<p>Provides the input for an external signal onto which the Calibrator can be phase locked. (1 V rms to 10 V rms, 10 kΩ input impedance.) The connector shell is not connected directly to chassis ground. It is connected internally to the OUTPUT LO binding post. The maximum allowable potential between the connector shell and chassis ground is 20 V peak. Refer to "Phase Locking to an External Signal," in Chapter 4 of the Operators Manual for details.</p>
<p>⑥ AC PWR INPUT Connector</p>	<p>A grounded male three-prong connector that accepts the mains power cord.</p>
<p>⑦ Master ON/OFF Switch</p>	<p>This switch must be in the ON (I) position before the soft power button on the front panel will function.</p>
<p>⑧ F1 Fuse Holder</p>	<p>Line power fuse. Refer to "Fuse Replacement" for fuse rating information and the fuse replacement procedure.</p>
<p>⑨ Chassis Ground Binding Post</p>	<p>A binding post that is internally grounded to the chassis. If the Calibrator is the location of the ground reference point in a system, this binding post can be used for connecting other instruments to earth ground. (The chassis is normally connected to earth ground through the three-conductor line cord instead of through the earth ground binding post.) Refer to "Connect the Calibrator to the UUT" in Chapter 4 of the Operators Manual for details.</p>
<p>⑩ Rear USB Port</p>	<p>USB port for remote control of the Calibrator. Chapter 5 of the Operators Manual describes how to connect to the USB interface. Refer Chapter 6 of the Operators Manual for remote programming instructions.</p>
<p>⑪ RS 232 Connector</p>	<p>A male (DTE) serial port connector for remote control of the Calibrator. Chapter 5 of the Operators Manual describes proper cabling and how to set up the Serial interface and connect to it. Refer to Chapter 6 of the Operators Manual for remote programming instructions.</p>
<p>⑫ Ethernet Connector</p>	<p>100 Base/T Ethernet connector for remote control of the Calibrator. Chapter 5 of the Operators Manual describes proper cabling, how to set up the interface, and how to transmit data from the Calibrator. Chapter 5 of the Operators Manual also describes how to use the Ethernet interface for remote control.</p>
<p>⑬ IEEE-488 Connector</p>	<p>A standard interface connector for operating the Calibrator in remote control as a Talker or Listener on the IEEE-488 Bus. Refer to Chapter 5 of the Operators Manual for bus connection. Refer to Chapter 6 of the Operators Manual for remote programming instructions.</p>

General Specifications

Warm-Up Time	Twice the time since last warmed up, to a maximum of 30 minutes.
System Installation	Rack mount kits available.
Standard Interfaces	IEEE-488, RS-232, USB 2.0 device, Ethernet, 5725A, 52120A, phase lock in (BNC), phase reference out (BNC).
Temperature Performance	
Operating	0 °C to 50 °C
Calibration.....	15 °C to 35 °C
Storage	-40 °C to 75 °C
Relative Humidity	
Operating	<80 % to 30 °C, <70 % to 40 °C, <40 % to 50 °C
Storage	<95 %, non-condensing. A power stabilization period of four days may be required after extended storage at high temperature and humidity.
Safety	IEC 61010-1: Overvoltage Category II, Pollution Degree 2
Operating Altitude	2000 m maximum
Guard Isolation	20 V
Electromagnetic Compatibility (EMC)	
IEC 61326-1 (Controlled EM environment).....	IEC 61326-2-1; CISPR 11: Group 1, Class A Group 1 equipment has intentionally generated and/or use conductively coupled radio-frequency energy which is necessary for the internal functioning of the equipment itself. Class A equipment is equipment suitable for use in all establishments other than domestic and those directly connected to a low voltage power supply network which supplies buildings used for domestic purposes. Emissions which exceed the levels required by CISPR 11 can occur when the equipment is connected to a test object. The equipment may not meet the immunity requirements of 61326-1 when test leads and/or test probes are connected.
USA (FCC).....	47 CFR 15 subpart B, this product is considered an exempt device per clause 15.103
Korea (KCC)	Class A Equipment (Industrial Broadcasting & Communication Equipment) This product meets requirements for industrial (Class A) electromagnetic wave equipment and the seller or user should take notice of it. This equipment is intended for use in business environments and not to be used in homes.
Line Power	
Line Voltage	
5730A	100 V-120 V, 220 V- 240 V ±10 %
5725A	100 V, 110 V, 115 V, 120 V, 200 V, 220 V, 230 V, 240 V, ±10 %
Line Frequency	47 Hz-63 Hz
Maximum Power	
5730A	300 VA
5725A	750 VA

Weight

- 5730A 27 kg (62 lb)
- 5725A 32 kg (70 lb)

Size

5730A

- Height 17.8 cm (7 in), standard rack increment, plus 1.5 cm (0.6 in) for feet
- Width 43.2 cm (17 in), standard rack width
- Depth 64.8 cm (25.5 in), overall; 59.4 cm (23.4 in), rack depth

5725A

- Height 13.3 cm (5.25 in)
- Width and Depth Both units project 5.1 cm (2 in) from rack front.

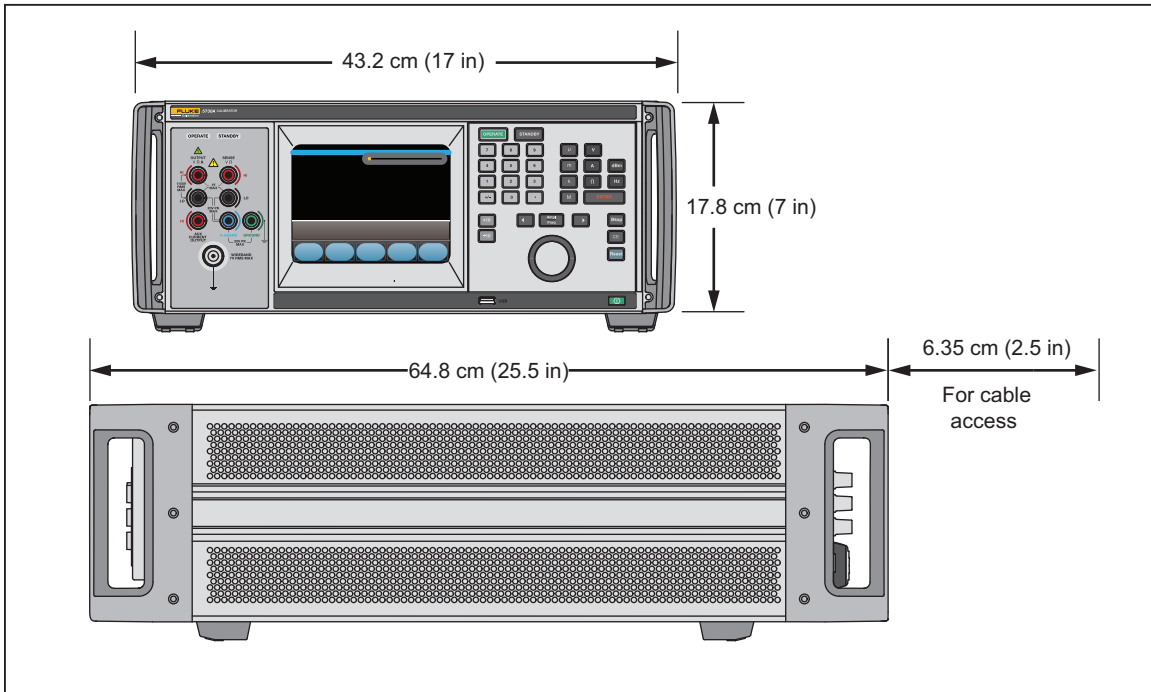

hhp002.eps

Figure 5. Product Dimensions

Artifact Calibration Standards Requirements

The following external standards are necessary to calibrate the 5730A to the listed specification. Each external standard used must have an uncertainty equal to or less than the listed uncertainty limit.

Fluke Standard	Traceable Quantity	Nominal Value	Uncertainty Limit	5730A Specifications Susceptible to Uncertainty Limit
732B	Voltage	10 V	1.5 ppm	dc volts, ac volts, dc current, ac current
742A-1	Resistance	1 Ω	10 ppm	1 Ω, 1.9 Ω
742A-10k	Resistance	10 kΩ	2 ppm	ac current, dc current 10 Ω to 100 MΩ

Electrical Specifications

The product specifications describe the Absolute Instrumental Uncertainty of the Product. The product specifications include stability, temperature, and humidity; within specified limits, linearity, line and load regulation, and the reference standard measurement uncertainty. The product specifications are provided at a 99 %, k=2.58, normally distributed and a 95 %, k=2, normally distributed level of confidence. Fluke Calibration guarantees product performance to the 99 % level of confidence.

The relative specifications are provided for enhanced accuracy applications. The specifications apply when range constants are adjusted (see "Range Calibration"). To Calculate an enhanced absolute specification from the relative accuracy specification, it is necessary to combine the uncertainty of your external standards with the pertinent relative specifications.

Specifications are valid after allowing a warm-up period of 30 minutes, or twice the time the Product has been turned off.
DC Voltage Specifications

5730A DC Voltage Specifications

Range	Resolution	Absolute / ± 5 °C from calibration temperature				Relative ± 1 °C	
		24 Hours	90 Days	180 Days	1 Year	24 Hours	90 Days
$\pm(\text{ppm output}^{[1]} + \mu\text{V})$							
99 % Confidence Level							
220 mV	10 nV	5 + 0.5	7 + 0.5	8 + 0.5	9 + 0.5	2 + 0.4	2.5 + 0.4
2.2 V	100 nV	3.5 + 0.8	4 + 0.8	4.5 + 0.8	6 + 0.8	2 + 0.8	2.5 + 0.8
11 V	1 μV	2.5 + 3	3 + 3	3.5 + 3	4 + 3	1 + 3	1.5 + 3
22 V	1 μV	2.5 + 5	3 + 5	3.5 + 5	4 + 5	1 + 5	1.5 + 5
220 V	10 μV	3.5 + 50	4 + 50	5 + 50	6 + 50	2 + 50	2.5 + 50
1100 V	100 μV	5 + 500	6 + 500	7 + 500	8 + 500	2.5 + 400	3 + 400
95 % Confidence Level							
220 mV	10 nV	4 + 0.4	6 + 0.4	6.5 + 0.4	7.5 + 0.4	1.6 + 0.4	2 + 0.4
2.2 V	100 nV	3 + 0.7	3.5 + 0.7	4 + 0.7	5 + 0.7	1.6 + 0.7	2 + 0.7
11 V	1 μV	2 + 2.5	2.5 + 2.5	3 + 2.5	3.5 + 2.5	0.8 + 2.5	1.2 + 2.5
22 V	1 μV	2 + 4	2.5 + 4	3 + 4	3.5 + 4	0.8 + 4	1.2 + 4
220 V	10 μV	3 + 40	3.5 + 40	4 + 40	5 + 40	1.6 + 40	2 + 40
1100 V	100 μV	4 + 400	4.5 + 400	6 + 400	6.5 + 400	2 + 400	2.4 + 400
Notes:							
Perform the DC Zero calibration every 30 days. In addition, perform the DC Zero calibration after powering up the unit the first time after unpacking following a shipment or if exposed to an environmental change of greater than 5 °C.							
1. For radiated EMI fields >400 MHz and <500 MHz, add 1 ppm.							

DC Voltage Secondary Performance Specifications and Operating Characteristics

Range	Stability ^[1] ± 1 °C 24 Hours	Temperature Coefficient Adder ^[2]		Linearity ± 1 °C	Noise	
		10 - 40 °C	0 - 10 °C and 40 - 50 °C		Bandwidth 0.1 - 10 Hz pk-pk	Bandwidth 10 - 10 kHz RMS
	$\pm(\text{ppm output} + \mu\text{V})$	$\pm(\text{ppm output} + \mu\text{V}) / \text{°C}$	$\pm(\text{ppm output} + \mu\text{V})$	μV		
220 mV	0.3 + 0.3	0.4 + 0.1	1.5 + 0.5	1 + 0.2	0.15 + 0.1	5
2.2 V	0.3 + 1	0.3 + 0.1	1.5 + 2	1 + 0.6	0.15 + 0.4	15
11 V	0.3 + 2.5	0.15 + 0.2	1 + 1.5	0.3 + 2	0.15 + 2	50
22 V	0.4 + 5	0.2 + 0.4	1.5 + 3	0.3 + 4	0.15 + 4	50
220 V	0.5 + 40	0.3 + 5	1.5 + 40	1 + 40	0.15 + 60	150
1100 V	0.5 + 200	0.5 + 10	3 + 200	1 + 200	0.15 + 300	500
Notes:						
1. Stability specifications are included in the absolute specification values in the primary specification tables.						
2. Temperature coefficient is an adder to accuracy specifications that does <i>not</i> apply unless operating more than ± 5 °C from calibration temperature.						

Minimum Output 0 V for all ranges, except 100 V for 1100 V range
Maximum Load 50 mA for 2.2 V through 220 V ranges; 20 mA for 1100 V range; 50 Ω output impedance on 220 mV range; all ranges <1000 pF, >25 Ω
Load Regulation <(0.2 ppm of output + 0.1 ppm of range), full load to no load
Line Regulation <0.1 ppm change, ± 10 % of selected nominal line
Settling Time 3 seconds to full specification; + 1 second for range or polarity change; + 1 second for 1100 V range
Overshoot <5 %
Common Mode Rejection 140 dB, DC to 400 Hz
Remote Sensing Available 0 V to ± 1100 V, on 2.2 V through 1100 V ranges

AC Voltage Specifications

5730A AC Voltage Specifications: 99 % Confidence Level

Range	Resolution	Frequency (Hz)	Absolute / ± 5 °C from calibration temperature				Relative ± 1 °C	
			24 Hours	90 Days	180 Days	1 Year	24 Hours	90 Days
			\pm (ppm output + μ V)					
2.2 mV	1 nV	10 - 20	250 + 5	270 + 5	290 + 5	300 + 5	250 + 5	270 + 5
		20 - 40	100 + 5	105 + 5	110 + 5	115 + 5	100 + 5	105 + 5
		40 - 20 k	85 + 5	90 + 5	95 + 5	100 + 5	60 + 5	65 + 5
		20 k - 50 k	220 + 5	230 + 5	240 + 5	250 + 5	85 + 5	95 + 5
		50 k - 100 k	500 + 6	540 + 6	570 + 6	600 + 6	200 + 6	220 + 6
		100 k - 300 k	1000 + 12	1200 + 12	1250 + 12	1300 + 12	350 + 12	400 + 12
		300 k - 500 k	1400 + 25	1500 + 25	1600 + 25	1700 + 25	800 + 25	1000 + 25
500 k - 1 M	2900 + 25	3100 + 25	3250 + 25	3400 + 25	2700 + 25	3000 + 25		
22 mV	10 nV	10 - 20	250 + 5	270 + 5	290 + 5	300 + 5	250 + 5	270 + 5
		20 - 40	100 + 5	105 + 5	110 + 5	115 + 5	100 + 5	105 + 5
		40 - 20 k	85 + 5	90 + 5	95 + 5	100 + 5	60 + 5	65 + 5
		20 k - 50 k	220 + 5	230 + 5	240 + 5	250 + 5	85 + 5	95 + 5
		50 k - 100 k	500 + 6	540 + 6	570 + 6	600 + 6	200 + 6	220 + 6
		100 k - 300 k	1000 + 12	1200 + 12	1250 + 12	1300 + 12	350 + 12	400 + 12
		300 k - 500 k	1400 + 25	1500 + 25	1600 + 25	1700 + 25	800 + 25	1000 + 25
500 k - 1 M	2900 + 25	3100 + 25	3250 + 25	3400 + 25	2700 + 25	3000 + 25		
220 mV	100 nV	10 - 20	250 + 15	270 + 15	290 + 15	300 + 15	250 + 15	270 + 15
		20 - 40	100 + 8	105 + 8	110 + 8	115 + 8	100 + 8	105 + 8
		40 - 20 k	65 + 8	66 + 8	67 + 8	70 + 8	60 + 8	65 + 8
		20 k - 50 k	135 + 8	140 + 8	145 + 8	150 + 8	85 + 8	95 + 8
		50 k - 100 k	370 + 20	380 + 20	390 + 20	400 + 20	200 + 20	220 + 20
		100 k - 300 k	650 + 25	700 + 25	750 + 25	800 + 25	350 + 25	400 + 25
		300 k - 500 k	1400 + 30	1500 + 30	1600 + 30	1700 + 30	800 + 30	1000 + 30
500 k - 1 M	2700 + 60	2900 + 60	3100 + 60	3300 + 60	2600 + 60	2800 + 60		
2.2 V	1 μ V	10 - 20	250 + 50	270 + 50	290 + 50	300 + 50	250 + 50	270 + 50
		20 - 40	95 + 20	100 + 20	105 + 20	110 + 20	95 + 20	100 + 20
		40 - 20 k	45 + 10	46 + 10	47 + 10	48 + 10	30 + 10	40 + 10
		20 k - 50 k	75 + 12	77 + 12	78 + 12	80 + 12	70 + 12	75 + 12
		50 k - 100 k	95 + 40	97 + 40	98 + 40	100 + 40	100 + 40	105 + 40
		100 k - 300 k	350 + 100	370 + 100	380 + 100	400 + 100	270 + 100	290 + 100
		300 k - 500 k	1000 + 250	1100 + 250	1150 + 250	1200 + 250	900 + 250	1000 + 250
500 k - 1 M	1600 + 400	1800 + 400	1900 + 400	2000 + 400	1200 + 400	1300 + 400		

Range	Resolution	Frequency (Hz)	Absolute / ± 5 °C from calibration temperature				Relative ± 1 °C	
			24 Hours	90 Days	180 Days	1 Year	24 Hours	90 Days
$\pm(\text{ppm output} + \mu\text{V})$								
22 V	10 μV	10 - 20	250 + 500	270 + 500	290 + 500	300 + 500	250 + 500	270 + 500
		20 - 40	95 + 200	100 + 200	105 + 200	110 + 200	95 + 200	100 + 200
		40 - 20 k	45 + 70	46 + 70	47 + 70	48 + 70	30 + 70	40 + 70
		20 k - 50 k	75 + 120	77 + 120	78 + 120	80 + 120	70 + 120	75 + 120
		50 k - 100 k	95 + 250	97 + 250	98 + 250	100 + 250	100 + 250	105 + 250
		100 k - 300 k	285 + 800	290 + 800	295 + 800	300 + 800	270 + 800	290 + 800
		300 k - 500 k	1000 + 2500	1100 + 2500	1150 + 2500	1200 + 2500	900 + 2500	1000 + 2500
500 k - 1 M	1500 + 4000	1600 + 4000	1700 + 4000	1800 + 4000	1300 + 4000	1400 + 4000		
$\pm(\text{ppm output} + \text{mV})$								
220 V ^[2]	100 μV	10 - 20	250 + 5	270 + 5	290 + 5	300 + 5	250 + 5	270 + 5
		20 - 40	95 + 2	100 + 2	105 + 2	110 + 2	95 + 2	100 + 2
		40 - 20 k	57 + 0.7	60 + 0.7	62 + 0.7	65 + 0.7	45 + 0.7	50 + 0.7
		20 k - 50 k	90 + 1.2	95 + 1.2	97 + 1.2	100 + 1.2	75 + 1.2	80 + 1.2
		50 k - 100 k	160 + 3	170 + 3	175 + 3	180 + 3	140 + 3	150 + 3
		100 k - 300 k	900 + 20	1000 + 20	1050 + 20	1100 + 20	600 + 20	700 + 20
		300 k - 500 k	5000 + 50	5200 + 50	5300 + 50	5400 + 50	4500 + 50	4700 + 50
500 k - 1 M	8000 + 100	9000 + 100	9500 + 100	10,000 + 100	8000 + 100	8500 + 100		
1100 V ^[1]	1 mV	15 - 50	300 + 20	320 + 20	340 + 20	360 + 20	300 + 20	320 + 20
		50 - 1 k	70 + 4	75 + 4	80 + 4	85 + 4	50 + 4	55 + 4
5725A Amplifier:								
1100 V	1 mV	40 - 1 k	75 + 4	80 + 4	85 + 4	90 + 4	50 + 4	55 + 4
		1 k - 20 k	105 + 6	125 + 6	135 + 6	165 + 6	85 + 6	105 + 6
		20 k - 30 k	230 + 11	360 + 11	440 + 11	600 + 11	160 + 11	320 + 11
750 V		30 k - 50 k	230 + 11	360 + 11	440 + 11	600 + 11	160 + 11	320 + 11
		50 k - 100 k	600 + 45	1300 + 45	1600 + 45	2300 + 45	380 + 45	1200 + 45
Notes:								
1. Maximum output 250 V from 15-50 Hz.								
2. See Volt-Hertz capability in Figure A.								

5730A AC Voltage Specifications: 95 % Confidence Level

Range	Resolution	Frequency (Hz)	Absolute / ± 5 °C from calibration temperature				Relative ± 1 °C	
			24 Hours	90 Days	180 Days	1 Year	24 Hours	90 Days
			$\pm(\text{ppm output} + \mu\text{V})$					
2.2 mV	1 nV	10 - 20	200 + 4	220 + 4	230 + 4	240 + 4	200 + 4	220 + 4
		20 - 40	80 + 4	85 + 4	87 + 4	90 + 4	80 + 4	85 + 4
		40 - 20 k	70 + 4	75 + 4	77 + 4	80 + 4	50 + 4	55 + 4
		20 k - 50 k	170 + 4	180 + 4	190 + 4	200 + 4	70 + 4	80 + 4
		50 k - 100 k	400 + 5	460 + 5	480 + 5	500 + 5	160 + 5	180 + 5
		100 k - 300 k	800 + 10	900 + 10	1000 + 10	1050 + 10	280 + 10	320 + 10
		300 k - 500 k	1100 + 20	1200 + 20	1300 + 20	1400 + 20	650 + 20	800 + 20
		500 k - 1 M	2400 + 20	2500 + 20	2600 + 20	2700 + 20	2100 + 20	2400 + 20
22 mV	10 nV	10 - 20	200 + 4	220 + 4	230 + 4	240 + 4	200 + 4	220 + 4
		20 - 40	80 + 4	85 + 4	87 + 4	90 + 4	80 + 4	85 + 4
		40 - 20 k	70 + 4	75 + 4	77 + 4	80 + 4	50 + 4	55 + 4
		20 k - 50 k	170 + 4	180 + 4	190 + 4	200 + 4	70 + 4	80 + 4
		50 k - 100 k	400 + 5	460 + 5	480 + 5	500 + 5	160 + 5	180 + 5
		100 k - 300 k	800 + 10	900 + 10	1000 + 10	1050 + 10	280 + 10	320 + 10
		300 k - 500 k	1100 + 20	1200 + 20	1300 + 20	1400 + 20	650 + 20	800 + 20
		500 k - 1 M	2400 + 20	2500 + 20	2600 + 20	2700 + 20	2100 + 20	2400 + 20
220 mV	100 nV	10 - 20	200 + 12	220 + 12	230 + 12	240 + 12	200 + 12	220 + 12
		20 - 40	80 + 7	85 + 7	87 + 7	90 + 7	80 + 7	85 + 7
		40 - 20 k	54 + 7	55 + 7	56 + 7	57 + 7	50 + 7	55 + 7
		20 k - 50 k	105 + 7	110 + 7	115 + 7	120 + 7	70 + 7	80 + 7
		50 k - 100 k	296 + 17	298 + 17	303 + 17	310 + 17	160 + 17	180 + 17
		100 k - 300 k	535 + 20	583 + 20	600 + 20	655 + 20	280 + 20	320 + 20
		300 k - 500 k	1100 + 25	1200 + 25	1300 + 25	1400 + 25	650 + 25	800 + 25
		500 k - 1 M	2400 + 45	2500 + 45	2600 + 45	2700 + 45	2100 + 45	2400 + 45
2.2 V	1 μV	10 - 20	200 + 40	220 + 40	230 + 40	240 + 40	200 + 40	220 + 40
		20 - 40	75 + 15	80 + 15	85 + 15	90 + 15	75 + 15	80 + 15
		40 - 20 k	37 + 8	39 + 8	40 + 8	42 + 8	25 + 8	35 + 8
		20 k - 50 k	61 + 10	63 + 10	65 + 10	67 + 10	55 + 10	60 + 10
		50 k - 100 k	79 + 30	81 + 30	82 + 30	85 + 30	80 + 30	85 + 30
		100 k - 300 k	276 + 80	300 + 80	314 + 80	336 + 80	230 + 80	250 + 80
		300 k - 500 k	800 + 200	900 + 200	950 + 200	1000 + 200	700 + 200	800 + 200
		500 k - 1 M	1300 + 300	1500 + 300	1600 + 300	1700 + 300	1000 + 300	1100 + 300
22 V	10 μV	10 - 20	200 + 400	220 + 400	230 + 400	240 + 400	200 + 400	220 + 400
		20 - 40	75 + 150	80 + 150	85 + 150	90 + 150	75 + 150	80 + 150
		40 - 20k	37 + 50	39 + 50	40 + 50	42 + 50	25 + 50	35 + 50
		20k - 50k	61 + 100	63 + 100	65 + 100	67 + 100	55 + 100	60 + 100
		50k - 100k	78 + 200	80 + 200	81 + 200	83 + 200	80 + 200	85 + 200
		100k - 300k	238 + 600	243 + 600	249 + 600	254 + 600	250 + 600	270 + 600
		300k - 500k	800 + 2000	900 + 2000	900 + 2000	1000 + 2000	700 + 2000	800 + 2000
		500k - 1M	1200 + 3200	1300 + 3200	1400 + 3200	1500 + 3200	1100 + 3200	1200 + 3200

Range	Resolution	Frequency (Hz)	Absolute / $\pm 5^\circ\text{C}$ from calibration temperature				Relative $\pm 1^\circ\text{C}$	
			24 Hours	90 Days	180 Days	1 Year	24 Hours	90 Days
			$\pm(\text{ppm output} + \mu\text{V})$					
			$\pm(\text{ppm output} + \text{mV})$					
220 V ^[2]	100 μV	10 - 20	200 + 4	220 + 4	230 + 4	240 + 4	200 + 4	220 + 4
		20 - 40	75 + 1.5	80 + 1.5	85 + 1.5	90 + 1.5	75 + 1.5	80 + 1.5
		40 - 20 k	45 + 0.6	47 + 0.6	50 + 0.6	52 + 0.6	35 + 0.6	40 + 0.6
		20 k - 50 k	70 + 1	75 + 1	77 + 1	80 + 1	60 + 1	65 + 1
		50 k - 100 k	120 + 2.5	130 + 2.5	140 + 2.5	150 + 2.5	110 + 2.5	120 + 2.5
		100 k - 300 k	700 + 16	800 + 16	850 + 16	900 + 16	500 + 16	600 + 16
		300 k - 500 k	4000 + 40	4200 + 40	4300 + 40	4400 + 40	3600 + 40	3800 + 40
500 k - 1 M	6000 + 80	7000 + 80	7500 + 80	8000 + 80	6500 + 80	7000 + 80		
1100 V ^[1]	1 mV	15 - 50	240 + 16	260 + 16	280 + 16	300 + 16	240 + 16	260 + 16
		50 - 1 k	55 + 3.5	60 + 3.5	65 + 3.5	70 + 3.5	40 + 3.5	45 + 3.5
5725A Amplifier:								
1100 V	1 mV	40 - 1 k	75 + 4	80 + 4	85 + 4	90 + 4	50 + 4	55 + 4
		1 k - 20 k	105 + 6	125 + 6	135 + 6	165 + 6	85 + 6	105 + 6
		20 k - 30 k	230 + 11	360 + 11	440 + 11	600 + 11	160 + 11	320 + 11
750 V	1 mV	30 k - 50 k	230 + 11	360 + 11	440 + 11	600 + 11	160 + 11	320 + 11
		50 k - 100 k	600 + 45	1300 + 45	1600 + 45	2300 + 45	380 + 45	1200 + 45
Notes:								
1. Maximum output 250 V from 15-50 Hz.								
2. See Volt-Hertz capability in Figure A.								

AC Voltage Secondary Performance Specifications and Operating Characteristics

Range	Frequency (Hz)	Stability $\pm 1^\circ\text{C}$ ^[1] 24 Hours	Temperature Coefficient		Output Impedance (Ω)	Maximum Distortion Bandwidth 10 Hz - 10 MHz
			10 - 40 $^\circ\text{C}$	0 - 10 $^\circ\text{C}$ and 40 - 50 $^\circ\text{C}$		
		$\pm\mu\text{V}$	$\pm\mu\text{V} / ^\circ\text{C}$		$\pm(\% \text{ output} + \mu\text{V})$	
2.2 mV	10 - 20	5	0.05	0.05	50	0.05 + 10
	20 - 40	5	0.05	0.05		0.035 + 10
	40 - 20 k	2	0.05	0.05		0.035 + 10
	20 k - 50 k	2	0.1	0.1		0.035 + 10
	50 k - 100 k	3	0.2	0.2		0.035 + 30
	100 k - 300 k	3	0.3	0.3		0.3 + 30
	300 k - 500 k	5	0.4	0.4		0.3 + 30
500 k - 1 M	5	0.5	0.5	2 + 50		
22 mV	10 - 20	5	0.2	0.3	50	0.05 + 11
	20 - 40	5	0.2	0.3		0.035 + 11
	40 - 20 k	2	0.2	0.3		0.035 + 11
	20 k - 50 k	2	0.4	0.5		0.035 + 11
	50 k - 100 k	3	0.5	0.5		0.035 + 30
	100 k - 300 k	5	0.6	0.6		0.3 + 30
	300 k - 500 k	10	1	1		0.3 + 30
500 k - 1 M	15	1	1	2 + 30		
		$\pm(\text{ppm output} + \mu\text{V})$	$\pm(\text{ppm output } \mu\text{V}) / ^\circ\text{C}$			
220 mV	10 - 20	150 + 20	2 + 1	2 + 1	50	0.05 + 16
	20 - 40	80 + 15	2 + 1	2 + 1		0.035 + 16
	40 - 20 k	12 + 2	2 + 1	2 + 1		0.035 + 16
	20 k - 50 k	10 + 2	15 + 2	15 + 2		0.035 + 16
	50 k - 100 k	10 + 2	15 + 4	15 + 4		0.035 + 30
	100 k - 300 k	20 + 4	80 + 5	80 + 5		0.3 + 30
	300 k - 500 k	100 + 10	80 + 5	80 + 5		0.3 + 30
500 k - 1 M	200 + 20	80 + 5	80 + 5	1 + 30		

Range	Frequency (Hz)	Stability $\pm 1^\circ\text{C}^{[1]}$ 24 Hours	Temperature Coefficient		Output Impedance (Ω)	Maximum Distortion Bandwidth 10 Hz-10 MHz
			10 - 40 $^\circ\text{C}$	0 - 10 $^\circ\text{C}$ and 40 - 50 $^\circ\text{C}$		
		$\pm\mu\text{V}$	$\pm\mu\text{V} / ^\circ\text{C}$		Load Regulation $\pm(\text{ppm output} + \mu\text{V})$	$\pm(\% \text{ output} + \mu\text{V})$
2.2 V	10 - 20	150 + 20	50 + 10	50 + 10	10 + 2	0.05 + 80
	20 - 40	80 + 15	15 + 5	15 + 5	10 + 2	0.035 + 80
	40 - 20 k	12 + 4	2 + 1	5 + 2	10 + 4	0.035 + 80
	20 k - 50 k	15 + 5	10 + 2	15 + 4	30 + 10	0.035 + 80
	50 k - 100 k	15 + 5	10 + 4	20 + 4	120 + 16	0.035 + 110
	100 k - 300 k	30 + 10	80 + 15	80 + 15	300 ppm	0.3 + 110
	300 k - 500 k	70 + 20	80 + 40	80 + 40	600 ppm	0.5 + 110
500 k - 1 M	150 + 50	80 + 100	80 + 100	1200 ppm	1 + 110	
22 V	10 - 20	150 + 20	50 + 100	50 + 100	10 + 20	0.05 + 700
	20 - 40	80 + 15	15 + 30	15 + 40	10 + 20	0.035 + 700
	40 - 20 k	12 + 8	2 + 10	4 + 15	10 + 30	0.035 + 700
	20 k - 50 k	15 + 10	10 + 20	20 + 20	30 + 50	0.035 + 700
	50 k - 100 k	15 + 10	10 + 40	20 + 40	80 + 80	0.05 + 800
	100 k - 300 k	30 + 15	80 + 150	80 + 150	100 + 700	0.3 + 800
	300 k - 500 k	70 + 100	80 + 300	80 + 300	200 + 1100	0.3 + 800
500 k - 1 M	150 + 100	80 + 500	80 + 500	600 + 3000	2 + 800	
220 V	10 - 20	150 + 200	50 + 1000	50 + 1000	10 + 200	0.05 + 10,000
	20 - 40	80 + 150	15 + 300	15 + 300	10 + 200	0.05 + 10,000
	40 - 20 k	12 + 80	2 + 80	4 + 80	10 + 300	0.05 + 10,000
	20 k - 50 k	15 + 100	10 + 100	20 + 100	30 + 600	0.05 + 10,000
	50 k - 100 k	15 + 100	10 + 500	20 + 500	80 + 3,000	0.2 + 50,000
	100 k - 300 k	30 + 400	80 + 600	80 + 600	250 + 25,000	1.5 + 50,000
	300 k - 500 k	100 + 10,000	80 + 800	80 + 800	500 + 50,000	1.5 + 50,000
500 k - 1 M	200 + 20,000	80 + 1000	80 + 1000	1000 + 110,000	3.5 + 100,000	
		$\pm(\text{ppm output} + \text{mV})$	$\pm(\text{ppm output}) / ^\circ\text{C}$		$\pm(\text{ppm output} + \text{mV})$	$\pm(\% \text{ output})$
1100 V	15 - 50	150 + 0.5	50	50	10 + 2	0.15
	50 - 1 k	20 + 0.5	2	5	10 + 1	0.07

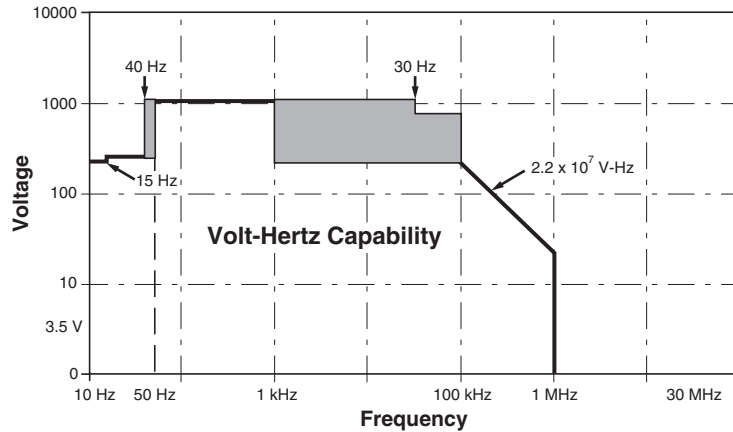

Figure A.

5725A Amplifier:							
Range	Frequency (Hz)	Stability ± 1 °C ^[1] 24 Hours	Temperature Coefficient Adder		Load Regulation ^[2]	Distortion Bandwidth 10 Hz -10 MHz \pm (% output)	
			10 - 40 °C	0 - 10 °C and 40 - 50 °C		150 pF	1000 pF
		\pm (ppm output + mV)	\pm (ppm output) / °C		\pm (ppm output + mV)		
1100 V	40 - 1 k	10 + .5	5	5	10 + 1	0.10	0.10
	1 k - 20 k	15 + 2	5	5	90 + 6	0.10	0.15
	20 k - 50 k	40 + 2	10	10	275 + 11	0.30	0.30
	50 k - 100 k	130 + 2	30	30	500 + 30	0.40	0.40
Notes:							
1. Stability specifications are included in Absolute specification values for the primary specifications.							
2. The 5725A will drive up to 1000 pF of load capacitance. Absolute specifications include loads to 300 pF and 150 pF as shown under "Load Limits." For capacitances up to the maximum of 1000 pF, add "Load Regulation."							

Voltage Range	Maximum Current Limits	Load Limits
2.2 V ^[2]		
22 V	50 mA, 0 °C-40 °C	>50 Ω ,
220 V	20 mA, 40 °C-50 °C	1000 pF
1100 V	6 mA	600 pF
5725A Amplifier:		
1100 V	40 Hz-5 kHz	50 mA
	5 kHz-30 kHz	70 mA
	30 kHz-100 kHz	70 mA ^[3]
Load Limits		
		1000 pF ^[1]
		300 pF
		150 pF
Notes:		
1. The 5725A will drive up to 1000 pF of load capacitance. Absolute specifications include loads to 300 pF and 150 pF as shown under "Load Limits." For capacitances up to the maximum of 1000 pF, add "Load Regulation."		
2. 2.2 V Range, 100 kHz-1.2 MHz only: Absolute specifications cover loads to 10 mA or 1000 pF. For higher loads, load regulation is added.		
3. Applies from 0 °C to 40 °C.		

Output Display Formats Voltage or dBm, dBm reference 600 Ω .

Minimum Output 10 % on each range

External Sense Applicable for 2.2 V, 22 V, 220 V, and 1100 V ranges; 5730A
<100 kHz, 5725A <30 kHz. Specifications are the same as internal sense.

Settling Time to Published Specifications

Frequency (Hz)	Settling Time (seconds)
10-120	7
>120	5
Notes:	
Plus 1 second for amplitude or frequency range change	
Plus 2 seconds for 5730A 1100 V range	
Plus 4 seconds for 5725A 1100 V range	

Nominal Value (Ω)	Absolute Specification of Characterized Value $\pm 5^\circ\text{C}$ from calibration temperature ^[1]				Relative $\pm 1^\circ\text{C}$	
	24 Hours	90 Days	180 Days	1 Year	24 Hours	90 Days
	$\pm\text{ppm}$					
95 % Confidence Level						
0	40 $\mu\Omega$	40 $\mu\Omega$	40 $\mu\Omega$	40 $\mu\Omega$	40 $\mu\Omega$	40 $\mu\Omega$
1	70	80	85	95	27	35
1.9	70	80	85	95	20	26
10	20	21	22	23	4	7
19	20	21	22	23	3.5	6
100	8	9	9.5	10	1.6	3.5
190	8	9	9.5	10	1.6	3.5
1 k	5.5	5.7	6	6.5	1.6	2.5
1.9 k	5.5	5.7	6	6.5	1.6	2.5
10 k	5	5.5	6	6.5	1.6	2.5
19 k	5	5.5	6	6.5	1.6	2.5
100 k	5.5	7.5	8	8.5	1.6	2.5
190 k	6	7	8	8.5	1.6	2.5
1 M	10	11	12	13	2	4
1.9 M	12	13.5	15	18	2.5	4
10 M	27	31	34	40	8	12
19 M	35	39	42	47	16	20
100 M	85	95	100	100	40	50

Note:
1. Specifications apply to displayed value. 4-wire connections, except 100 M Ω .

Resistance Secondary Performance Specifications and Operating Characteristics

Nominal Value (Ω)	Stability $\pm 1^\circ\text{C}$ ^[1] 24 Hours	Temperature Coefficient Adder ^[2]		Full Spec Load Range ^[3] $I_L - I_U$ (mA)	Maximum Peak Current I_{MAX} (mA)	Maximum Difference of Characterized to Nominal Value	Two-Wire Adder Active Compensation ^[4]	
		10 - 40 $^\circ\text{C}$	0 - 10 $^\circ\text{C}$ and 40 - 50 $^\circ\text{C}$				Lead Resistance	
		$\pm\text{ppm}$	$\pm\text{ppm}/^\circ\text{C}$			$\pm\text{ppm}$	0.1 Ω	1 Ω
0	—	—	—	8 - 500	500	—	$2 + \frac{4\mu\text{V}}{I_m}$	$4 + \frac{4\mu\text{V}}{I_m}$
1	32	4	5	8 - 100	700	500	$2 + \frac{4\mu\text{V}}{I_m}$	$4 + \frac{4\mu\text{V}}{I_m}$
1.9	25	6	7	8 - 100	500	500	$2 + \frac{4\mu\text{V}}{I_m}$	$4 + \frac{4\mu\text{V}}{I_m}$
10	5	2	3	8 - 11	220	300	$2 + \frac{4\mu\text{V}}{I_m}$	$4 + \frac{4\mu\text{V}}{I_m}$
19	4	2	3	8 - 11	160	300	$2 + \frac{4\mu\text{V}}{I_m}$	$4 + \frac{4\mu\text{V}}{I_m}$

Nominal Value (Ω)	Stability ±1 °C ^[1] 24 Hours	Temperature Coefficient Adder ^[2]		Full Spec Load Range ^[3] I _L - I _U (mA)	Maximum Peak Current I _{MAX} (mA)	Maximum Difference of Characterized to Nominal Value	Two-Wire Adder Active Compensation ^[4]	
		10 - 40 °C	0 - 10 °C and 40 - 50 °C				Lead Resistance	
	±ppm	±ppm/°C	0.1 Ω	1 Ω				
100	2	2	3	8 - 11	70	150	$2 + \frac{4\mu V}{I_m}$	$4 + \frac{4\mu V}{I_m}$
190	2	2	3	8 - 11	50	150	$2 + \frac{4\mu V}{I_m}$	$4 + \frac{4\mu V}{I_m}$
1 k	2	2	3	1 - 2	22	150	10	15
1.9 k	2	2	3	1 - 1.5	16	150	10	15
10 k	2	2	3	100 - 500 μA	7	150	50	60
19 k	2	2	3	50 - 250 μA	5	150	100	120
100 k	2	2	3	10 - 100 μA	1	150	I _m = Current produced by Ohmmeter (A)	
190 k	2	2	3	5 - 100 μA	500 μA	150		
1 M	2.5	2.5	6	5 - 20 μA	100 μA	200		
1.9 M	3.5	3	10	2.5 - 10 μA	50 μA	200		
10 M	10	5	20	0.5 - 2 μA	10 μA	300		
19 M	20	8	40	0.25 - 1 μA	5 μA	300		
100 M	50	12	100	50 - 200 nA	1 μA	500		

Notes:

- Stability specifications are included in the Absolute specification values in the primary specification tables.
- Temperature coefficient is an adder to Absolute specifications that does not apply unless operated more than 5 °C from calibration temperature, or calibrated outside the range 19 °C to 24 °C. Two examples:
 - Calibrate at 20 °C: Temperature coefficient adder is not required unless operated below 15 °C or above 25 °C.
 - Calibrate at 26 °C: Add 2 °C temperature coefficient adder. Additional temperature coefficient adder is not required unless operated below 21 °C or above 31 °C.
- Refer to current derating factors table for loads outside of this range.
- Active two-wire compensation may be selected for values less than 100 kΩ, with either the front panel or the meter input terminals as reference plane. Active compensation is limited to 11 mA load, and to 2 V burden. Two-wire compensation can be used only with Ω-meters that source continuous (not pulsed) dc current.

Current Derating Factors

Nominal Value (Ω)	Value of Derating Factor K for Over or Under Current		
	Two-Wire Comp $I < I_L$ ^[1]	Four-Wire $I < I_L$ ^[1]	Four-Wire $I_U < I < I_{MAX}$ ^[2]
SHORT	4.4	0.3	—
1	4.4	300	4×10^{-5}
1.9	4.4	160	1.5×10^{-4}
10	4.4	30	1.6×10^{-3}
19	4.4	16	3×10^{-3}
100	4.4	3.5	1×10^{-2}
190	4.4	2.5	1.9×10^{-2}
1 k	4.4	0.4	0.1
1.9 k	4.4	0.4	0.19
10 k	5000	50	2.0
19 k	5000	50	3.8
100 k	—	7.5	2×10^{-5}
190 k	—	4.0	3.8×10^{-5}
1 M	—	1.0	1.5×10^{-4}
1.9 M	—	0.53	2.9×10^{-4}
10 M	—	0.2	1×10^{-3}
19 M	—	0.53	1.9×10^{-3}
100 M	—	0.1	—

Notes:

- For $I < I_L$, errors occur due to thermally generated voltages within the 5730A. Use the following equation to determine the error, and add this error to the corresponding specifications.

$$\text{Error} = K(I_L - I)/(I_L \times I)$$
Where: Error is in m Ω for all two-wire comp values and four-wire short, and in ppm for the remaining four-wire values.
K is the constant from the above table;
I and I_L are expressed in mA for short to 1.9 k Ω ;
I and I_L are expressed in μ A for 10 k Ω to 100 M Ω
- For $I_U < I < I_{MAX}$ errors occur due to self-heating of the resistors in the calibrator. Use the following equation to determine the error in ppm and add this error to the corresponding specifications.

$$\text{Error in ppm} = K(I^2 - I_U^2)$$
Where: K is the constant from the above table;
I and I_U are expressed in mA for short to 19 k Ω ;
I and I_U are expressed in μ A for 100 k Ω to 100 M Ω

DC Current Specifications

5730A DC Current Specifications

Range	Resolution	Absolute / ± 5 °C from calibration temperature				Relative ± 1 °C	
		24 Hours	90 Days	180 Days	1 Year	24 Hours	90 Days
	nA	$\pm(\text{ppm output} + \text{nA})$					
99 % Confidence Level							
220 μA	0.1	40 + 7	42 + 7	45 + 7	50 + 7	24 + 2	26 + 2
2.2 mA	1	30 + 8	35 + 8	37 + 8	40 + 8	24 + 5	26 + 5
22 mA	10	30 + 50	35 + 50	37 + 50	40 + 50	24 + 50	26 + 50
	μA	$\pm(\text{ppm output} + \mu\text{A})$					
220 mA ^[1]	0.1	40 + 0.8	45 + 0.8	47 + 0.8	50 + 0.8	26 + 0.3	30 + 0.3
2.2 A ^[1]	1	60 + 15	70 + 15	80 + 15	90 + 15	40 + 7	45 + 7
5725A Amplifier:							
11 A	10	330 + 470	340 + 480	350 + 480	360 + 480	100 + 130	110 + 130
95 % Confidence Level							
	nA	$\pm(\text{ppm output} + \text{nA})$					
220 μA	0.1	32 + 6	35 + 6	37 + 6	40 + 6	20 + 1.6	22 + 1.6
2.2 mA	1	25 + 7	30 + 7	33 + 7	35 + 7	20 + 4	22 + 4
22 mA	10	25 + 40	30 + 40	33 + 40	35 + 40	20 + 40	22 + 40
	μA	$\pm(\text{ppm output} + \mu\text{A})$					
220 mA ^[1]	0.1	35 + 0.7	40 + 0.7	42 + 0.7	45 + 0.7	22 + 0.25	25 + 0.25
2.2 A ^[1]	1	50 + 12	60 + 12	70 + 12	80 + 12	32 + 6	40 + 6
5725A Amplifier:							
11 A	10	330 + 470	340 + 480	350 + 480	360 + 480	100 + 130	110 + 130
<p>Note:</p> <p>Maximum output from the calibrator's terminals is 2.2 A. Specifications for 220 μA and 2.2 mA ranges are increased by a factor of 1.3 when supplied through 5725A terminals.</p> <p>Specifications are otherwise identical for all output locations.</p> <p>1. Add to specifications:</p> <ul style="list-style-type: none"> $\pm 200 \times I^2$ ppm for >100 mA on 220 mA range $\pm 10 \times I^2$ ppm for >1 A on 2.2 A range 							

DC Current Secondary Performance Specifications and Operating Characteristics

Range	Stability $\pm 1\text{ }^\circ\text{C}$ ^[1] 24 Hours	Temperature Coefficient ^[2]		Compliance Limits	Burden Voltage Adder ^[3] ($\pm\text{nA/V}$)	Maximum Load for Published Specification ^[4] (Ω)	Noise	
		10 - 40 $^\circ\text{C}$	0 - 10 $^\circ\text{C}$ and 40 - 50 $^\circ\text{C}$				Bandwidth 0.1-10 Hz	Bandwidth 10 Hz-10 kHz
	$\pm(\text{ppm}$ output + nA)	$\pm(\text{ppm output} + \text{nA}) /$ $^\circ\text{C}$	pk-pk				RMS	
220 μA	5 + 1	1 + 0.40	3 + 1	10	0.2	20k	6 + .9	10
2.2 mA	5 + 5	1 + 2	3 + 10	10	0.2	2k	6 + 5	10
22 mA	5 + 50	1 + 20	3 + 100	10	10	200	6 + 50	50
220 mA	8 + 300	1 + 200	3 + 1 μA	10	100	20	9 + 300	500
2.2 A	9 + 7 μA	1 + 2.5 μA	3 + 10 μA	3 ^[5]	2 μA	2	12 + 1.5 μA	20 μA
5725A	$\pm(\text{ppm}$ output + μA)	$\pm(\text{ppm output} + \mu\text{A}) /$ $^\circ\text{C}$					ppm output + μA	μA
11 A	25 + 100	20 + 75	30 + 120	4	0	4	15 + 70	175

Notes:

Maximum output from the calibrator's terminals is 2.2 A. Specifications for 220 μA and 2.2 mA ranges are increased by a factor of 1.3 when supplied through 5725A terminals.

- Stability specifications are included in the Absolute specification values for the primary specifications.
- Temperature coefficient is an adder to Absolute specifications. It does not apply unless operating more than $\pm 5\text{ }^\circ\text{C}$ from calibration temperature.
- Burden voltage adder is an adder to Absolute specifications that does not apply unless burden voltage is greater than 0.5 V.

- For higher loads, multiply Absolute specification by: $1 + \frac{0.1 \times \text{actual load}}{\text{maximum load for published specification}}$

- The calibrator's compliance limit is 2 V for outputs from 1 A to 2.2 A. 5725A Amplifier may be used in range-lock mode down to 0 A.

Minimum Output 0 for all ranges, including 5725A.

Settling Time 1 second for μA and mA ranges; 3 seconds for 2.2 A range; 6 seconds for 11 range; + 1 second for range or polarity change

Overshoot <5 %

AC Current Specifications

5730A AC Current Specifications: 99 % Confidence Level

Range	Resolution	Frequency (Hz)	Absolute / ± 5 °C from calibration temperature				Relative ± 1 °C	
			24 Hours	90 Days	180 Days	1 Year	24 Hours	90 Days
			\pm (ppm output + nA)					
220 μ A	1 nA	10 - 20	260 + 20	280 + 20	290 + 20	300 + 20	260 + 20	280 + 20
		20 - 40	170 + 12	180 + 12	190 + 12	200 + 12	130 + 12	150 + 12
		40 - 1 k	115 + 10	117 + 10	118 + 10	120 + 10	100 + 10	110 + 10
		1 k - 5 k	300 + 15	320 + 15	340 + 15	350 + 15	250 + 15	280 + 15
		5 k - 10 k	1000 + 80	1100 + 80	1200 + 80	1300 + 80	900 + 80	1000 + 80
2.2 mA	10 nA	10 - 20	260 + 50	280 + 50	290 + 50	300 + 50	260 + 50	280 + 50
		20 - 40	170 + 40	180 + 40	190 + 40	200 + 40	130 + 40	150 + 40
		40 - 1 k	115 + 40	117 + 40	118 + 40	120 + 40	100 + 40	110 + 40
		1 k - 5 k	210 + 130	220 + 130	230 + 130	240 + 130	190 + 130	220 + 130
		5 k - 10 k	1000 + 800	1100 + 800	1200 + 800	1300 + 800	900 + 800	1000 + 800
22 mA	100 nA	10 - 20	260 + 500	280 + 500	290 + 500	300 + 500	260 + 500	280 + 500
		20 - 40	170 + 400	180 + 400	190 + 400	200 + 400	130 + 400	150 + 400
		40 - 1 k	115 + 400	117 + 400	118 + 400	120 + 400	100 + 400	110 + 400
		1 k - 5 k	210 + 700	220 + 700	230 + 700	240 + 700	190 + 700	220 + 700
		5 k - 10 k	1000 + 6000	1100 + 6000	1200 + 6000	1300 + 6000	900 + 6000	1000 + 6000
			\pm (ppm output + μ A)					
220 mA	1 μ A	10 - 20	260 + 5	280 + 5	290 + 5	300 + 5	260 + 5	280 + 5
		20 - 40	170 + 4	180 + 4	190 + 4	200 + 4	130 + 4	150 + 4
		40 - 1 k	115 + 3	117 + 3	118 + 3	120 + 3	100 + 3	110 + 3
		1 k - 5 k	210 + 4	220 + 4	230 + 4	240 + 4	190 + 4	220 + 4
		5 k - 10 k	1000 + 12	1100 + 12	1200 + 12	1300 + 12	900 + 12	1000 + 12
2.2 A	10 μ A	20 - 1 k	270 + 40	280 + 40	290 + 40	300 + 40	260 + 40	280 + 40
		1 k - 5 k	440 + 100	460 + 100	480 + 100	500 + 100	420 + 100	440 + 100
		5 k - 10 k	6000 + 200	7000 + 200	7500 + 200	8000 + 200	6000 + 200	7000 + 200
5725A Amplifier:								
11 A	100 μ A	40 - 1 k	370 + 170	400 + 170	440 + 170	460 + 170	300 + 170	330 + 170
		1 k - 5 k	800 + 380	850 + 380	900 + 380	950 + 380	700 + 380	800 + 380
		5 k - 10 k	3000 + 750	3300 + 750	3500 + 750	3600 + 750	2800 + 750	3200 + 750
<p>Note: Maximum output from the calibrator's terminals is 2.2 A. Specifications for 220 μA and 2.2 mA ranges are increased by a factor of 1.3 plus 2 μA when supplied through 5725A terminals.</p>								

5730A AC Current Specifications: 95 % Confidence Level

Range	Resolution	Frequency (Hz)	Absolute / ± 5 °C from calibration temperature				Relative ± 1 °C	
			24 Hours	90 Days	180 Days	1 Year	24 Hours	90 Days
			$\pm(\text{ppm output} + \text{nA})$					
220 μA	1 nA	10 - 20	210 + 16	230 + 16	240 + 16	250 + 16	210 + 16	230 + 16
		20 - 40	130 + 10	140 + 10	150 + 10	160 + 10	110 + 10	130 + 10
		40 - 1 k	96 + 8	99 + 8	101 + 8	103 + 8	80 + 8	90 + 8
		1 k - 5 k	240 + 12	250 + 12	270 + 12	280 + 12	200 + 12	230 + 12
		5 k - 10 k	800 + 65	900 + 65	1000 + 65	1100 + 65	700 + 65	800 + 65
2.2 mA	10 nA	10 - 20	210 + 40	230 + 40	240 + 40	250 + 40	210 + 40	230 + 40
		20 - 40	130 + 35	140 + 35	150 + 35	160 + 35	110 + 35	130 + 35
		40 - 1 k	96 + 35	99 + 35	101 + 35	103 + 35	80 + 35	90 + 35
		1 k - 5 k	170 + 110	180 + 110	190 + 110	200 + 110	160 + 110	170 + 110
		5 k - 10 k	800 + 650	900 + 650	1000 + 650	1100 + 650	700 + 650	800 + 650
22 mA	100 nA	10 - 20	210 + 400	230 + 400	240 + 400	250 + 400	210 + 400	230 + 400
		20 - 40	130 + 350	140 + 350	150 + 350	160 + 350	110 + 350	130 + 350
		40 - 1 k	96 + 350	99 + 350	101 + 350	103 + 350	80 + 350	90 + 350
		1 k - 5 k	170 + 550	180 + 550	190 + 550	200 + 550	160 + 550	170 + 550
		5 k - 10 k	800 + 5000	900 + 5000	1000 + 5000	1100 + 5000	700 + 5000	800 + 5000
$\pm(\text{ppm output} + \mu\text{A})$								
220 mA	1 μA	10 - 20	210 + 4	230 + 4	240 + 4	250 + 4	210 + 4	230 + 4
		20 - 40	130 + 3.5	140 + 3.5	150 + 3.5	160 + 3.5	110 + 3.5	130 + 3.5
		40 - 1 k	96 + 2.5	99 + 2.5	101 + 2.5	103 + 2.5	80 + 2.5	90 + 2.5
		1 k - 5 k	170 + 3.5	180 + 3.5	190 + 3.5	200 + 3.5	160 + 3.5	170 + 3.5
		5 k - 10 k	800 + 10	900 + 10	1000 + 10	1100 + 10	700 + 10	800 + 10
2.2 A	10 μA	20 - 1 k	214 + 35	224 + 35	234 + 35	244 + 35	200 + 35	230 + 35
		1 k - 5 k	350 + 80	390 + 80	420 + 80	450 + 80	300 + 80	350 + 80
		5 k - 10 k	5000 + 160	6000 + 160	6500 + 160	7000 + 160	5000 + 160	6000 + 160
5725A Amplifier:								
11 A	100 μA	40 - 1 k	370 + 170	400 + 170	440 + 170	460 + 170	300 + 170	330 + 170
		1 k - 5 k	800 + 380	850 + 380	900 + 380	950 + 380	700 + 380	800 + 38
		5 k - 10 k	3000 + 750	3300 + 750	3500 + 750	3600 + 750	2800 + 750	3200 + 750
Note: Maximum output from the calibrator's terminals is 2.2 A. Specifications for 220 μA and 2.2 mA ranges are increased by 1.3 plus 2 μA when supplied through 5725A terminals.								

AC Current Secondary Performance Specifications and Operating Characteristics

Range	Frequency (Hz)	Stability $\pm 1\text{ }^\circ\text{C}$ ^[1] 24 Hours	Temperature Coefficient ^[2]		Compliance Limits (V rms)	Maximum Resistive Load For Published Specification ^[3] (Ω)	Noise and Distortion (Bandwidth 10 Hz - 50 kHz <0.5V Burden)
			10 - 40 $^\circ\text{C}$	0 - 10 $^\circ\text{C}$ and 40 - 50 $^\circ\text{C}$			
		$\pm(\text{ppm output} + \text{nA})$	$\pm(\text{ppm output} + \text{nA})/^\circ\text{C}$				$\pm(\% \text{ output} + \mu\text{A})$
220 μA	10 - 20	150 + 5	50 + 5	50 + 5	7	2 k	0.05 + 0.1
	20 - 40	80 + 5	20 + 5	20 + 5			0.05 + 0.1
	40 - 1 k	30 + 3	4 + 0.5	10 + 0.5			0.05 + 0.1
	1 k - 5 k	50 + 20	10 + 1	20 + 1			0.25 + 0.5
	5 k - 10 k	400 + 100	20 + 100	20 + 100			0.05 + 1
2.2 mA	10 - 20	150 + 5	50 + 5	50 + 5	7	800	0.05 + 0.1
	20 - 40	80 + 5	20 + 4	20 + 4			0.05 + 0.1
	40 - 1 k	30 + 3	4 + 1	10 + 2			0.05 + 0.1
	1 k - 5 k	50 + 20	10 + 100	20 + 100			0.25 + 0.5
	5 k - 10 k	400 + 100	50 + 400	50 + 400			0.05 + 1
22 mA	10 - 20	150 + 50	50 + 10	50 + 10	7	80	0.05 + 0.1
	20 - 40	80 + 50	20 + 10	20 + 10			0.05 + 0.1
	40 - 1 k	30 + 30	4 + 10	10 + 20			0.05 + 0.1
	1 k - 5 k	50 + 500	10 + 500	20 + 400			0.25 + 0.5
	5 k - 10 k	400 + 1000	50 + 1000	50 + 1000			0.05 + 1
	Hz	$\pm(\text{ppm output} + \mu\text{A})$	$\pm(\text{ppm output} + \mu\text{A})/^\circ\text{C}$				
220 mA	10 - 20	150 + 0.5	50 + 0.05	50 + 0.05	7	8	0.05 + 10
	20 - 40	80 + 0.5	20 + 0.05	20 + 0.05			0.05 + 10
	40 - 1 k	30 + 0.3	4 + 0.1	10 + 0.1			0.05 + 10
	1 k - 5 k	50 + 3	10 + 2	20 + 2			0.25 + 50
	5 k - 10 k	400 + 5	50 + 5	50 + 5			0.05 + 100
2.2 A	20 - 1 k	50 + 5	4 + 1	10 + 1	1.4 ^[4]	0.8	0.5 + 100
	1 k - 5 k	80 + 20	10 + 5	20 + 5			0.3 + 500
	5 k - 10 k	800 + 50	50 + 10	50 + 10			1 + 1 mA
5725A Amplifier:							$\pm(\% \text{ output})$
11 A	40 - 1 k	75 + 100	20 + 75	30 + 75	3	3	0.05 ^[5]
	1 k - 5 k	100 + 150	40 + 75	50 + 75			0.12 ^[5]
	5 k - 10 k	200 + 300	100 + 75	100 + 75			0.5 ^[5]
<p>Notes:</p> <p>Maximum output from 5730A terminals is 2.2 A. Specifications for 220 μA and 2.2 mA ranges are increased by a factor of 1.3, plus 2 μA when supplied through 5725A terminals. Specifications are otherwise identical for all output locations.</p> <ol style="list-style-type: none"> Stability specifications are included in the Absolute values for the primary specifications. Temperature coefficient is an adder to specifications that does not apply unless operating more than $\pm 5\text{ }^\circ\text{C}$ from calibration temperature. For larger resistive loads multiply accuracy specifications by: $\left(\frac{\text{actual load}}{\text{maximum load for published specification}} \right)^2$ 1.5 V compliance limit above 1 A. 5725A Amplifier may be used in range-lock mode down to 1 A. For resistive loads within rated compliance voltage limits. 							

Minimum Output	9 μ A for 220 μ A range, 10 % on all other ranges. 1 A minimum for 5725A.
Inductive Load Limits	400 μ H (5730A, or 5725A). 20 μ H for 5730A output >1 A.
Power Factors	5730A, 0.9 to 1; 5725A, 0.1 to 1. Subject to compliance voltage limits.
Frequency	
Range (Hz)	10.000 - 11.999, 12.00 - 119.99, 120.0 - 1199.9, 1.200 k - 10.000 k
Specification	\pm 0.01 % of output
Resolution	11,999 counts
Settling Time	5 seconds for 5730A ranges; 6 seconds for 5725A 11 A range; +1 second for amplitude or frequency range change.
Overshoot	<10 %

Wideband AC Voltage (Option 5730A/03 and 5730A/05) Specifications (99 % Confidence Level)

Specifications apply to the end of the cable and 50 Ω termination used for calibration.

Range		Resolution	Absolute / ± 5 $^{\circ}$ C from calibration temperature 30 Hz - 500 kHz			
Volts	dBm		24 Hours	90 Days	180 Days	1 Year
\pm (% output + μ V)						
1.1 mV	-46	10 nV	0.4 + 0.4	0.5 + 0.4	0.6 + 0.4	0.8 + 2
3.3 mV	-37	10 nV	0.4 + 1	0.45 + 1	0.5 + 1	0.7 + 3
11 mV	-26	100 nV	0.2 + 4	0.35 + 4	0.5 + 4	0.7 + 8
33 mV	-17	100 nV	0.2 + 10	0.3 + 10	0.45 + 10	0.6 + 16
110 mV	-6.2	1 μ V	0.2 + 40	0.3 + 40	0.45 + 40	0.6 + 40
330 mV	+3.4	1 μ V	0.2 + 100	0.25 + 100	0.35 + 100	0.5 + 100
1.1 V	+14	10 μ V	0.2 + 400	0.25 + 400	0.35 + 400	0.5 + 400
3.5 V	+24	10 μ V	0.15 + 500	0.2 + 500	0.3 + 500	0.4 + 500

Frequency (Hz)	Frequency Resolution (Hz)	Amplitude Flatness, 1 kHz Reference Voltage Range			Temperature Coefficient \pm ppm/ $^{\circ}$ C	Settling Time To Published Specification (Seconds)	Harmonic Distortion (dB)
		1.1 mV	3.3 mV	>3.3 mV			
\pm (% output + floor indicated)							
10 - 30	0.01	0.3	0.3	0.3	100	7	-40
30 - 119.99	0.01	0.1	0.1	0.1	100	7	-40
120 - 1.1999 k	0.1	0.1	0.1	0.1	100	5	-40
1.2 k - 11.999 k	1	0.1	0.1	0.1	100	5	-40
12 k - 119.99 k	10	0.1	0.1	0.1	100	5	-40
120 k - 1.1999 M	100	0.2 + 3 μ V	0.1 + 3 μ V	0.1 + 3 μ V	100	5	-40
1.2 M - 2 M ^[1]	1 k	0.2 + 3 μ V	0.1 + 3 μ V	0.1 + 3 μ V	100	0.5	-40
2 M - 11.9 M	1 k	0.4 + 3 μ V	0.3 + 3 μ V	0.2 + 3 μ V	100	0.5	-40
12 M - 20 M	10 k	0.6 + 3 μ V	0.5 + 3 μ V	0.4 + 3 μ V	150	0.5	-34
20 M - 30 M	10 k	1.5 + 15 μ V	1.5 + 3 μ V	1 + 3 μ V	300	0.5	-34
30 M - 50 M ^[2]	10 k	3.0 + 15 μ V	3.0 + 3 μ V	2.0 + 3 μ V	600	0.5	-34

Note:

- For output voltages <50 % of full range in the 33 mV, 110 mV, 330 mV, 1.1 V, and 3.5 V ranges, add 0.1 % to the amplitude flatness specification.

Additional Operating Information:

dBm reference = 50 Ω

Range boundaries are at voltage points, dBm levels are approximate.

$$\text{dBm} = 10 \log \left(\frac{\text{Power}}{1 \text{ mW}} \right); 0.22361 \text{ V across } 50 \Omega = 1 \text{ mW or } 0 \text{ dBm}$$

- Applies to Option 5730A/05 only.

Minimum Output	300 μ V (-57 dBm)
VSWR at Output Terminal	<1.1 Typical
Frequency Specification	\pm 0.01 % of output
Frequency Resolution	11,999 counts to 1.1999 MHz, 10799 counts to 11.999 MHz, 3800 counts to 50 MHz
Overload Protection	A short circuit on the wideband output will not result in damage. After settling time, normal operation is restored upon removal.

52120A Specifications when Operated with the 5730A

Line Power

Voltage range	100 V to 240 V
Frequency	47 to 63 Hz
Voltage variations	\pm 10 % about line voltage
Power consumption	<1500 VA

Dimensions (HxWxL)

With feet.....	192 mm x 432 mm x 645 mm (7.6 in x 17.0 in x 25.5 in)
Without feet.....	178 mm x 432 mm x 645 mm (7.0 in x 17.0 in x 25.5 in)

Weight 25 kg (54 lb)

Temperature

Operating	5 °C to 35 °C (41 °F to 95 °F)
Calibration (tcal).....	16 °C to 30 °C (61 °F to 86 °F)
Storage	0 °C to 50 °C (32 °F to 122 °F)
Transit.....	-20 °C to +60 °C (-4 °F to +140 °F) <100 hours

Warmup Time Twice the time since last warmed up, to a maximum of 1 hour.

Humidity (non-condensing)

Operating	<80 %, 5 °C to 31 °C (41 °F to 88 °F) ramping linearly down to 50 % at 35 °C (95 °F)
Storage	<95 %, 0 to 50 °C (32 °F to 122 °F)

Altitude

Operating	2,500 m (8,200 ft) maximum
Non-Operating	12,000 m (39,400 ft) maximum

Shock and Vibration MIL-PRF-28800F Class 3

Safety EN/IEC 61010-1, 300 V CAT II, Pollution Degree 2

Electromagnetic Environment IEC 61326-1, Industrial

Electromagnetic Compatibility FCC Rules part 15 sub part B

Applies to use in Korea only. Class A Equipment (Industrial Broadcasting & Communication Equipment)^[1]

[1] This product meets requirements for industrial (Class A) electromagnetic wave equipment and the seller or user should take notice of it. This equipment is intended for use in business environments and is not to be used in homes.

Indoor use only IP20

52120A Electrical Performance Limits

Voltage compliance developed across inductive loads may prevent range maximum current output being achieved at higher frequencies. The appropriate maximum frequency (F_{max}) for a given load inductance and current is given by:

$$F_{max} = \frac{4.5}{2 \cdot \pi \cdot I \cdot L}$$

I = Current
L = Total inductance

The maximum frequency calculated with this equation is only approximate. Series resistance and parallel capacitance also affect the maximum achievable frequency.

Input Common Mode Rejection 80 dB @ DC decreasing linearly to 40 dB at 10 kHz

Input Impedance

Voltage input >1 MΩ

Current input 10 Ω

Maximum Output Compliance Voltage 4.5 V rms (6.4 V pk), 6.4 V dc. 120 A range maximum compliance voltage decreases from 4.5 V at 1 kHz to about 3 V at 10 kHz

DC Offset Magnetic remanence that follows abrupt changes in output current level may cause small changes to DC current offset. It is good practice to correct for offsets in DC measurements and techniques such as DC reversal measurement will result in best accuracy.

Operated within 5730A Control Loop (all current ranges)

The current specification of the 52120A, when controlled by a single 5730A, applies to the parallel output of up to three 52120As connected as slaves.

Coverage factor $k=2.58$ (99 % confidence level)

Current Specification

Frequency	1-year, $t_{cal}^{[1]} \pm 5^\circ C \pm (\% \text{ of output} + \% \text{ of range})$	
	5730A	
	% of output	% of range
DC	0.015	0.010
10 Hz to 850 Hz	0.011	0.003
850 Hz to 6 kHz	0.052	0.005
6 kHz to 10 kHz	See Operated Stand Alone current specification table in the 52120A Users Manual.	
Notes:		
1. t_{cal} is the temperature at which calibration adjustment took place.		
Maximum inductance for stability LCOMP OFF is 100 μH. Maximum inductance for stability LCOMP ON is 400 μH for 2 A and 20 A ranges. 100 μH on the 120 A range.		
With LCOMP ON, the output is limited to 7.2e3 A-Hz. For example, a 100 A output is limited to 72 Hz.		

Coverage factor $k=2.00$ (95 % confidence level)

Current Specification

Frequency	1-year, $t_{cal}^{[1]} \pm 5^\circ\text{C} \pm (\% \text{ of output} + \% \text{ of range})$	
	5730A	
	% of output	% of range
DC	0.012	0.008
10 Hz to 850 Hz	0.009	0.002
850 Hz to 6 kHz	0.040	0.004
6 kHz to 10 kHz	See Operated Stand Alone current specification table in the 52120A Users Manual.	
Notes: 1. t_{cal} is the temperature at which calibration adjustment took place. Maximum inductance for stability LCOMP OFF is 100 μH . Maximum inductance for stability LCOMP ON is 400 μH for 2 A and 20 A ranges. 100 μH on the 120 A range. With LCOMP ON, the output is limited to 7.2e3 A-Hz. For example, a 100 A output is limited to 72 Hz.		

Maximum Distortion and Noise

Frequency	Distortion ^[1]				Noise 16 Hz to 10 MHz
	LCOMP OFF		LCOMP ON		
	dBc	Current	dBc	Current	
2 Amp Range					
16 Hz to 850 Hz	-76	42 μA	-70	83 μA	-60 dB
850 Hz to 6 kHz	-52	662 μA	-46	1.3 mA	-60 dB
6 kHz to 10 kHz ^[2]	-40	2.6 mA	-35	4.7 mA	-60 dB
20 Amp Range					
16 Hz to 850 Hz	-76	418 μA	-60	2.6 mA	-70 dB
850 Hz to 6 kHz	-52	6.6 mA	-42	20.9 mA	-70 dB
6 kHz to 10 kHz ^[2]	-40	26.4 mA	-35	46.9 mA	-70 dB
120 Amp Range					
16 Hz to 850 Hz	-76	2.5 mA	-60	15.8 mA	-70 dB
850 Hz to 6 kHz	-52	39.7 mA	-42	125.7 mA	-70 dB
6 kHz to 10 kHz ^[2]	-40	158.2 ma	-35	281.3 mA	-70 dB
Notes: 1. Use dB or Current. Whichever is larger. 2. Interharmonics only above 6 kHz.					

52120A/COIL 3 kA 25-Turn Coil**Number of Turns** 25**Minimum internal jaw dimension to clear wires** 26 mm (width) x 36 mm (length)**Maximum Input Current** 120 A continuous with built-in 12 V fan on**Maximum Voltage** 4.5 V rms**Specification**

Input Current ^[1]	Frequency	Effective Current Amp-turns	52120A + Coil Specification ^[2] ±(% of Amp-turns + % of 52120A range)	
			% of Amp-turns	% of 52120A Range
0 A to 100 A	DC	0 to 2500	0.7 %	0.7 %
0 A to 120 A	10 Hz to 65 Hz	0 to 3000	0.7 %	0.7 %
0 A to 120 A	65 Hz to 300 Hz	0 to 3000	0.7 %	0.7 %
0 A to 40 A	300 Hz to 1 kHz	0 to 1000	0.7 %	0.7 %
0 A to 12 A	1 kHz to 3 kHz	0 to 300	0.8 %	1.0 %
0 A to 3 A	3 kHz to 6 kHz	0 to 75	1.5 %	1.0 %
0 A to 1 A	6 kHz to 10 kHz	0 to 25	5.0 %	1.0 %

Notes:

- The inductance and mutual inductance of the 25 turn coil and clamp that is measured causes a frequency dependent compliance voltage across the coil. The length and configuration of the cables that connect the current to the coil also have an effect. Maximum input current is 120 A input at approximately 100 Hz. Maximum current input decreases to approximately 0.8 A at 10 kHz.
- Includes coil/clamp interaction.

52120A/COIL 6 kA 50-Turn Coil**Number of Turns** 50**Minimum Flexible Probe Length** 500 mm**Maximum Input Current** 120 A continuous with built-in 12 V fan on**Maximum Voltage** 4.5 V rms**Specification**

Input Current ^[1]	Frequency	Effective Current Amp-turns	52120A + Coil Specification ^[2] ±(% of Amp-turns + % of 52120A range)	
			% of Amp-turns	% of 52120A Range
0 A to 100 A	DC	0 to 5000	0.7 %	0.7 %
0 A to 120 A	10 Hz to 65 Hz	0 to 6000	0.7 %	0.7 %
0 A to 120 A	65 Hz to 300 Hz	0 to 6000	0.7 %	0.7 %
0 A to 120 A	300 Hz to 1 kHz	0 to 6000	0.7 %	0.7 %
0 A to 120 A	1 kHz to 3 kHz	0 to 6000	0.8 %	1.0 %
0 A to 25 A	3 kHz to 6 kHz	0 to 1250	1.5 %	1.0 %
0 A to 13 A	6 kHz to 10 kHz	0 to 650	5.0 %	1.0 %

Notes:

- The inductance and mutual inductance of the 50 turn coil causes a frequency dependent compliance voltage across the coil. Maximum frequency for 120 A input current is approximately 600 Hz. Maximum current input decreases to approximately 13 A at 10 kHz.
- Includes coil/probe interaction.

Note

The specifications for these coils are at 99 % confidence level and are the combined specification of the coil and a 52 120A. If the coils are used with other current sources the calibration specification of the coils alone is 0.65 % (99 % confidence level) from 0 Hz to 10 kHz.

Operating Limits

	Output Current Range		
	2 A	20 A	120 A
Current Output (Max.)	2 A rms	20 A rms	120 A rms
	Current Input		
Input Current (Max.)	200 mA rms	200 mA rms	120 mA rms
Current gain	10	100	1,000
	Voltage Input		
Input Voltage (Max.)	2 V rms	2 V rms	1.2 V rms
Transconductance	1 Siemen	10 Siemens	100 Siemens

120 A Range Current/Frequency Limits

Frequency	Maximum Output Current	Maximum Current Input	Maximum Voltage Input
DC	±100 A	±100 mA	±1.0 V
<10 Hz	100 A pk (70 A rms)	100 mA pk (70 mA rms)	1.0 V pk (0.7 V rms)
10 Hz to 10 kHz	170 A pk (120 A rms)	170 mA pk (120 mA rms)	1.7 V pk (1.2 V rms)
Note: The 2 A and 20 A ranges operate at full output current from DC to 10 kHz.			

Output Isolation

Frequency	Maximum Voltage Signal Applied to any Output Current Terminal with respect to Earth
DC to 850 Hz	600 V rms, 850 V pk, limited 2 A rms, no transient overvoltages
850 Hz to 3 kHz	100 V rms, 142 V pk, limited 2 A rms, no transient overvoltages
3 kHz to 10 kHz	33 V rms, 47 V pk, limited 2 A rms, no transient overvoltages

