

FLUKE®

Hart Scientific®

1521

*Handheld Thermometer Readout
User's Guide*

Limited Warranty & Limitation of Liability

Each product from Fluke's Hart Scientific Division ("Hart") is warranted to be free from defects in material and workmanship under normal use and service. The warranty period is one year for the Handheld Thermometer Readout. The warranty period begins on the date of the shipment. Parts, product repairs, and services are warranted for 90 days. The warranty extends only to the original buyer or end-user customer of a Hart authorized reseller, and does not apply to fuses, disposable batteries or to any other product which, in Hart's opinion, has been misused, altered, neglected, or damaged by accident or abnormal conditions of operation or handling. Hart warrants that software will operate substantially in accordance with its functional specifications for 90 days and that it has been properly recorded on non-defective media. Hart does not warrant that software will be error free or operate without interruption. Hart does not warrant calibrations on Handheld Thermometer Readouts.

Hart authorized resellers shall extend this warranty on new and unused products to end-user customers only but have no authority to extend a greater or different warranty on behalf of Hart. Warranty support is available if product is purchased through a Hart authorized sales outlet or Buyer has paid the applicable international price. Hart reserves the right to invoice Buyer for importation costs of repairs/replacement parts when product purchased in one country is submitted for repair in another country.

Hart's warranty obligation is limited, at Hart's option, to refund of the purchase price, free of charge repair, or replacement of a defective product which is returned to a Hart authorized service center within the warranty period.

To obtain warranty service, contact your nearest Hart authorized service center or send the product, with a description of the difficulty, postage, and insurance prepaid (FOB Destination), to the nearest Hart authorized service center. Hart assumes no risk for damage in transit. Following warranty repair, the product will be returned to Buyer, transportation prepaid (FOB Destination). If Hart determines that the failure was caused by misuse, alteration, accident or abnormal condition or operation or handling, Hart will provide an estimate or repair costs and obtain authorization before commencing the work. Following repair, the product will be returned to the Buyer transportation prepaid and the Buyer will be billed for the repair and return transportation charges (FOB Shipping Point).

THIS WARRANTY IS BUYER'S SOLE AND EXCLUSIVE REMEDY AND IS IN LIEU OF ALL OTHER WARRANTIES, EXPRESS OR IMPLIED, INCLUDING BUT NOT LIMITED TO ANY IMPLIED WARRANTY OF MERCHANTABILITY OR FITNESS FOR A PARTICULAR PURPOSE. HART SHALL NOT BE LIABLE FOR ANY SPECIAL, INDIRECT, INCIDENTAL OR CONSEQUENTIAL DAMAGES OR LOSSES, INCLUDING LOSS OF DATA, WHETHER ARISING FROM BREACH OF WARRANTY OR BASED ON CONTRACT, TORT, RELIANCE OR ANY OTHER THEORY.

Since some countries or states do not allow limitation of the term of an implied warranty, or exclusion or limitation of incidental or consequential damages, the limitations and exclusions of this warranty may not apply to every buyer. If any provision of this Warranty is held invalid or unenforceable by a court of competent jurisdiction, such holding will not affect the validity or enforceability of any other provision.

Fluke Corporation, Hart Scientific Division

799 E. Utah Valley Drive American Fork, UT 84003-9775 USA

Phone: +1.801.763.1600 Telefax: +1.801.763.1010

E-mail: support@hartscientific.com

www.hartscientific.com

Subject to change without notice. Copyright © 2005 Printed in USA

Table of Contents

1	Before You Start	1
1.1	Symbols Used	1
1.2	Safety Information	2
1.2.1	Warnings	2
1.2.2	Cautions	3
1.3	Authorized Service Centers.	4
2	Introduction	7
3	Specifications and Environmental Conditions	9
3.1	Specifications	9
3.2	Environmental Conditions.	10
4	Quick Start	11
4.1	Unpacking	11
4.2	Use Proper Care with the 1521 and Accessories	11
4.3	Learn About the Features and Components	11
4.4	Connect the Probe	11
4.5	Connect the Power Source	12
4.6	Switch the Power On	12
4.7	Measure Temperature	12
5	Parts and Controls	13
5.1	Front Features	13
5.2	Top and Side Features	15
5.3	Back Features	16
5.4	Internal Features.	16
5.5	Accessories	17
6	General Operation	19
6.1	Battery.	19
6.2	DC Power Source	20
6.3	Power Button	21
6.4	Display and Backlight.	21
6.5	Probe	22

6.6	INFO-CON Connector	23
7	Display Functions.	25
7.1	Blank Mode	26
7.2	Min/Max Mode	27
7.3	Hold Mode	27
7.4	Delta(x) Mode.	27
7.5	Units.	28
7.6	Rate	28
7.7	Resolution	28
7.8	CAL MODE.	29
7.8.1	Mtr Due	30
7.8.2	Prb Due	30
7.8.3	Time.	30
7.8.4	Passcode.	30
7.8.5	Date	31
7.8.6	Probe Lock	31
7.8.7	Prb #.	31
7.8.8	Prb Type.	31
7.8.9	ITS-90.	32
7.8.10	IEC751	33
7.8.11	CVD.	33
7.8.12	YSI-400	34
7.8.13	THERM	34
7.8.14	Probe Wires	35
7.8.15	PCal	35
7.8.16	PDue	35
7.8.17	Filter.	36
7.8.18	MCal	36
7.8.19	MDue	36
7.8.20	CAL1 and CAL2	36
8	Communications Interface.	37
8.1	RS-232 Connection	37
8.2	Communication Command List	38
8.2.1	Primary Commands.	38
8.2.2	Calibration Commands	39
9	Calibration	43
9.1	Required Equipment.	43
9.2	Calibration Procedure	43
10	Maintenance	45

11 Troubleshooting	47
11.1 An Error Message Is Displayed	47
11.2 CE Comments	48
11.2.1 EMC Directive	48
11.2.1.1 Immunity Testing	49
11.2.1.2 Emission Testing	49
11.2.2 Low Voltage Directive (Safety)	49

Figures and Tables













- Table 1 International Electrical Symbols 1
- Figure 1 Front of the 1521 13
- Figure 2 Top and Side View 15
- Figure 3 INFO-CON Connector 17
- Figure 4 Battery Installation 19
- Figure 5 12V DC Power Source Polarity 21
- Figure 6 Probe Wiring Diagrams 24
- Figure 7 Operating Modes Flowchart 26
- Figure 8 RS-232 Wiring 37



1 Before You Start

1.1 Symbols Used

Table 1 lists the International Electrical Symbols. Some or all of these symbols may be used on the instrument or in this manual.

Table 1 International Electrical Symbols

Symbol	Description
	AC (Alternating Current)
	AC-DC
	Battery
	CE Complies with European Union Directives
	DC
	Double Insulated
	Electric Shock
	Fuse
	PE Ground
	Hot Surface (Burn Hazard)
	Read the User's Manual (Important Information)
	Off
	On

Symbol	Description
	Canadian Standards Association
CAT II	OVERVOLTAGE (Installation) CATEGORY II, Pollution Degree 2 per IEC1010-1 refers to the level of Impulse Withstand Voltage protection provided. Equipment of OVERVOLTAGE CATEGORY II is energy-consuming equipment to be supplied from the fixed installation. Examples include household, office, and laboratory appliances.
	C-TIC Australian EMC Mark
	The European Waste Electrical and Electronic Equipment (WEEE) Directive (2002/96/EC) mark.

1.2 Safety Information

Use this instrument only as specified in this manual. Otherwise, the protection provided by the instrument may be impaired.

The following definitions apply to the terms “Warning” and “Caution”.

- “Warning” identifies conditions and actions that may pose hazards to the user.
- “Caution” identifies conditions and actions that may damage the instrument being used.

1.2.1 Warnings

To avoid personal injury, follow these guidelines.

- **DO NOT** use this unit in environments other than those listed in the User’s Guide.
- Follow all safety guidelines listed in the User’s Guide.
- Calibration equipment should only be used by trained personnel.
- If this equipment is used in a manner not specified by the manufacturer, the protection provided by the equipment may be impaired.
- Before initial use, or after transport, or after storage in humid or semi-humid environments, or anytime the instrument has not been energized for more than 10 days, the instrument needs to be energized for a “dry-out” period of 2 hours before it can be assumed to meet all of the safety requirements of the IEC 1010-1. If the product is wet or has been in a wet environment, take necessary measures to remove moisture prior to applying power such as storage in a low humidity temperature chamber operating at 50°C for 4 hours or more.
- This instrument can measure extreme temperatures. Precautions must be taken to prevent personal injury or damage to objects. Probes may be extremely hot or cold. Cautiously handle probes to prevent personal injury.

Carefully place probes on a heat/cold resistant surface or rack until they reach room temperature.

- The AC adapter can present safety concerns if misused or damaged. To avoid the risk of electric shock or fire, do not use the AC adapter outdoors or in a dusty, dirty, or wet environment. If the cord, case, or plug of the adapter is damaged in any way, discontinue its use immediately and have it replaced. Never disassemble the AC adapter. Use only the AC adapter provided with the instrument or equivalent adapter recommended by the manufacturer of this instrument.
- The AC adapter has circuits with high voltage inside that could present danger of electrical shock or fire if exposed. If the AC adapter is damaged in any way or becomes hot, discontinue its use immediately, disconnect it from any AC supply, and have it replaced. Do not attempt to open, repair, or continue using a damaged or defective AC adapter.
- The instrument batteries can present danger if not handled properly. To avoid the risk of exposure to dangerous substances or explosion, immediately remove the batteries and discontinue use if they leak or become damaged. Never allow the batteries to be shorted, heated, punctured, or dropped. If the instrument is physically damaged, immediately remove the batteries to insure that they do not become shorted. While removed from the instrument, store the batteries in a location so that they do not come into contact with metal or fluids that might short circuit the batteries and where they are safe from excessive temperatures. Used batteries must be disposed of properly. Check your local regulations for additional information. You may return the used batteries to the manufacturer. Never dispose of batteries in fire which may result in explosion with the possibility of personal injury or property damage.
- **DO NOT** use this instrument in combination with any probe (RTD or thermistor) to measure the temperature or resistance of any device that is electrically energized. Severe electric shock, personal injury, or death may occur.

1.2.2

Cautions

To avoid possible damage to the instrument, follow these guidelines.

- If the instrument is dropped, struck, or handled in a way that causes internal or external physical damage, immediately unplug the AC adapter, remove the batteries, discontinue use, and contact the factory for repair. Do not attempt to disassemble or repair the instrument, batteries, or AC adapter. Refer repairs or replacement components to the manufacturer.
- The instrument and thermometer probes are sensitive and can be easily damaged. Always handle these devices with care. **DO NOT** allow them to be dropped, struck, stressed, or overheated.
- **DO NOT** leave the AC adapter plugged in for more than 24 consecutive hours or the battery life could be degraded.

- Probes are fragile devices which can be damaged by mechanical shock, overheating, and absorption of moisture or fluids in the wires or hub. Damage may not be visibly apparent but nevertheless can cause drift, instability, and loss of accuracy. Observe the following precautions:
- **DO NOT** allow probes to be dropped, struck, bent, or stressed.
- **DO NOT** overheat probes beyond their recommended temperature range.
- **DO NOT** allow any part of the probe other than the sheath to be immersed in fluid.
- **DO NOT** allow the probe hub or wires to be exposed to excessive temperatures.
- Keep the probe wires clean and away from fluids.

1.3 Authorized Service Centers

Please contact one of the following authorized Service Centers to coordinate service on your Hart product:

Fluke Corporaton, Hart Scientific Division

799 E. Utah Valley Drive
American Fork, UT 84003-9775
USA

Phone: +1.801.763.1600
Telefax: +1.801.763.1010
E-mail: support@hartscientific.com

Fluke Nederland B.V.

Customer Support Services
Science Park Eindhoven 5108
5692 EC Son
NETHERLANDS

Phone: +31-402-675300
Telefax: +31-402-675321
E-mail: ServiceDesk@fluke.nl

Fluke Int'l Corporation

Service Center - Instrimpex
Room 2301 Sciteck Tower
22 Jianguomenwai Dajie

Chao Yang District
Beijing 100004, PRC
CHINA

Phone: +86-10-6-512-3436
Telefax: +86-10-6-512-3437
E-mail: xingye.han@fluke.com.cn

Fluke South East Asia Pte Ltd.

Fluke ASEAN Regional Office
Service Center
60 Alexandra Terrace #03-16
The Comtech (Lobby D)
118502
SINGAPORE

Phone: +65 6799-5588
Telefax: +65 6799-5588
E-mail: antng@singa.fluke.com

When contacting these Service Centers for support, please have the following information available:

- Model Number
- Serial Number
- Voltage
- Complete description of the problem

2 Introduction

The 1521 Handheld Thermometer Readout is a low-cost, high-accuracy digital thermometer readout designed to be used with PRTs and thermistors. The unique combination of features makes this instrument suitable for a wide variety of applications in industry. Features and capabilities of the 1521 include the following:

- Measures with platinum resistance thermometers (PRTs) and thermistors
- Works with Hart's special INFO-CON probe connector (which is partially based on U.S. Patent 5,857,777) to automatically recognize the type of sensor and its characteristics
- Automatically alerts the operator when the probe calibration or meter calibration expires
- Measures with an accuracy of $\pm 0.025^{\circ}\text{C}$ at 25°C with PRTs and $\pm 0.005^{\circ}\text{C}$ at 25°C with thermistors
- Accepts three- or four-wire sensors to eliminate lead resistance errors
- Is immune to thermoelectric EMF
- Measures with a fast one-second measurement cycle
- Displays maximum, minimum, and delta temperatures
- Stores up to six measurements in memory
- Uses a unique factory-assigned pass-code to protect programmed settings
- Displays measurements and settings on a high-contrast LCD display
- Communicates with other equipment using an RS-232 serial interface
- Can be powered from its AC adapter or rechargeable battery

3 Specifications and Environmental Conditions

3.1 Specifications

Resistance Range	0Ω to 500 kΩ
Resistance Accuracy, PRT, one year†	0Ω to 25Ω: 0.002Ω 25Ω to 400Ω: 0.008% (80 ppm) of reading
Resistance Accuracy, thermistor, one year†	0Ω to 2 kΩ: 0.4Ω 2 kΩ to 200 kΩ: 0.02% (200 ppm) of reading 200 kΩ to 500 kΩ: 0.03% (300 ppm) of reading
Temperature Range	PRT: -200°C to 962°C (-328°F to 1764°F) Thermistor: -50°C to 150°C (-58°F to 302°F)
Temperature Accuracy, PRT†	-200°C to 100°C: ±0.025°C (0.045°F) 100°C to 400°C: ±0.05°C (0.09°F) 400°C to 800°C: ±0.1°C (0.18°F) 800°C to 962°C: ±0.15°C (0.27°F)
Temperature Accuracy, 2.25 kΩ thermistor†	-50 to 25°C: ±0.005°C (0.009°F) 25°C to 50°C: ±0.01°C (0.018°F) 50°C to 75°C: ±0.03°C (0.054°F) 75°C to 100°C: ±0.08°C (0.144°F)
Temperature Accuracy, 10 kΩ thermistor†	0 to 50°C: ±0.005°C (0.009°F) 50°C to 75°C: ±0.01°C (0.018°F) 75°C to 100°C: ±0.02°C (0.036°F) 100°C to 125°C: ±0.05°C (0.09°F) 125°C to 150°C: ±0.1°C (0.18°F)
Temperature Accuracy, 100 kΩ thermistor†	0 to 50°C: 0.006°C (0.011°F) 50°C to 150°C: 0.009°C (0.016°F)
Resistance Resolution	0.001Ω
Temperature Resolution	0.001°C, F, K, R
Probe	IEC-751 or DIN-43760 PRT Callendar-Van Dusen calibrated PRT; nominal 100Ω ITS-90 calibrated 25Ω or 100Ω PRT YSI-400 series or equivalent 2252Ω thermistor Steinhart-Hart thermistor polynomial; nominal R(25°C) 2kΩ to 100kΩ
Probe Connector	Hart Scientific INFO-CON connector
Maximum Acceptable Probe Lead Resistance	10Ω
Probe Excitation Current	PRT: 0.5 mA Thermistor: 5 μA
Measurement Period	1 second

Digital Filter	Exponential with adjustable time constant (1 to 60 seconds)
Remote Communications	RS-232 serial
Display	LCD, 6-digit x 7-segment with 16-character alphanumeric
Operating Temperature Range	0 to 40°C (32 to 104°F) absolute 15 to 35°C (59 to 95°F) full accuracy
Power	12 VDC (AC adapter included) Rechargeable NIMH batteries (included)
Safety	OVERVOLTAGE (Installation) CATEGORY II, Pollution Degree 2 per IEC1010-1 refers to the level of Impulse Withstand Voltage protection provided. Equipment of OVERVOLTAGE CATEGORY II is energy-consuming equipment to be supplied from the fixed installation. Examples include household, office, and laboratory appliances.
Size	7.75"H x 4.2"W x 1.5"D (20 cm H x 11 cm W x 4 cm D)
Weight	0.4 kg (1.0 lb.)

†Accuracy specifications apply from 15 to 35°C. Accuracy specifications over the entire absolute operating range are 1.5 times the stated values. Temperature accuracy does not include probe uncertainty or probe characterization errors. The practical measurement range may be limited by the sensor.

3.2 Environmental Conditions

Although the instrument has been designed for optimum durability and trouble-free operation, it must be handled with care. The instrument should not be operated in an excessively dusty, dirty, or wet environment. Maintenance and cleaning recommendations can be found in the Maintenance section of this manual.

For full accuracy, operate the instrument in ambient temperatures between 15-35°C (59-95°F). Do not operate the instrument in an environment colder than 5°C (41°F) or warmer than 50°C (122°F).

The instrument operates safely under the following conditions:

- Operating temperature range: absolute 5–50°C (41–122°F); full accuracy 15-35°C (59-95°F)
- ambient relative humidity: maximum 80% for temperature <31°C, decreasing linearly to 50% at 40°C
- Pressure: 75kPa-106kPa
- Vibration should be minimized
- Altitude less than 2,000 meters
- Indoor use only

4 Quick Start

This section briefly explains the basics of setting up and operating your 1521 Thermometer.

4.1 Unpacking

Carefully unpack the 1521 and accessories and inspect them to make sure all components are present and in satisfactory condition. Verify that the following items are present:

- 1521 Thermometer
- AC Adapter (clamp-on ferrite installed)
- Serial Cable
- User's Guide
- Report of Calibration
- Calibration Label
- Pass-code Notice
- INFO-CON Connector
- Clamp-on ferrite with instructions for probe
- Probe (optional—must be purchased separately)

If all items are not present, call an Authorized Service Center (see Section 1.3).

4.2 Use Proper Care with the 1521 and Accessories

First and most important is to understand the safety issues related to the 1521 and its accessories. Be aware that potential hazards exist due to high temperatures, high voltages, and battery chemicals. Carefully read Section .



CAUTION: *The 1521 and any thermometer probes are sensitive instruments that can be easily damaged. Always handle these devices with care. DO NOT allow them to be dropped, struck, stressed, or overheated.*

4.3 Learn About the Features and Components

Familiarize yourself with the features and accessories of the 1521 by reading Section 5.

4.4 Connect the Probe

The PRT or thermistor probe connects to the top of the 1521 using Hart's unique INFO-CON probe connector. The probe connector is inserted into the

top of the instrument with the ridged side down. It will fit snugly and lock into place when it is fully inserted.

The INFO-CON probe connector includes a memory device that **stores the unique characteristics of the probe**, allowing the 1521 to measure temperature accurately. If your probe was purchased from Hart for use with the 1521 it should already have the connector attached and properly programmed. You can use your own probe with the 1521, but you must attach it with an INFO-CON connector. See Section 6.6 for more information on the INFO-CON connector.

4.5 Connect the Power Source

The 1521 draws power from either a DC power supply (the included AC adapter) connected to the DC input or the internal rechargeable battery pack. To use the AC adapter, plug it into a wall outlet of the appropriate voltage and insert the DC plug into the DC power input of the 1521 (see Figure 2.) To use the battery pack it must first be fully charged using the AC adapter (see Section 6.1).

4.6 Switch the Power On

Power is switched on and off with the power button located below and to the left of the display. To switch the power on, hold the power button down for at least two seconds. (To switch power off, momentarily press the power button again.) The instrument takes a few seconds to power up, initialize itself, and begin normal operation. During initialization the lower line of the display shows the manufacturer, model number, firmware version, and the state of battery charge or the message “External power” if the AC adapter is attached. The 1521 reads important information about the attached probe from the INFO-CON connector that it subsequently uses to calculate temperature.

The 1521 then performs a memory check of critical parameters, such as the calibration parameters CAL1 and CAL2. During this check the lower line of the display reads “Checking Memory”. If a “Memory Error” or “Memory Recover” message is displayed, see Section 12.1, Troubleshooting, for additional information and instructions.

4.7 Measure Temperature

After initialization the upper line of the display will begin to show temperature measurements sensed at the tip of the probe. Place the tip of the probe into the object that you want to measure the temperature. **DO NOT** force the probe or otherwise allow it to be bent, stressed, or overheated. It can be easily damaged if misused. For further suggestions on handling the probe and using the 1521 and probe to measure temperature accurately, see Section 6.5. For information on the various modes of operation of the 1521 see Section 7.

5 Parts and Controls

The functions of the various features of the 1521 are described below.

5.1 Front Features

The front of the 1521 features the LCD display and control buttons.

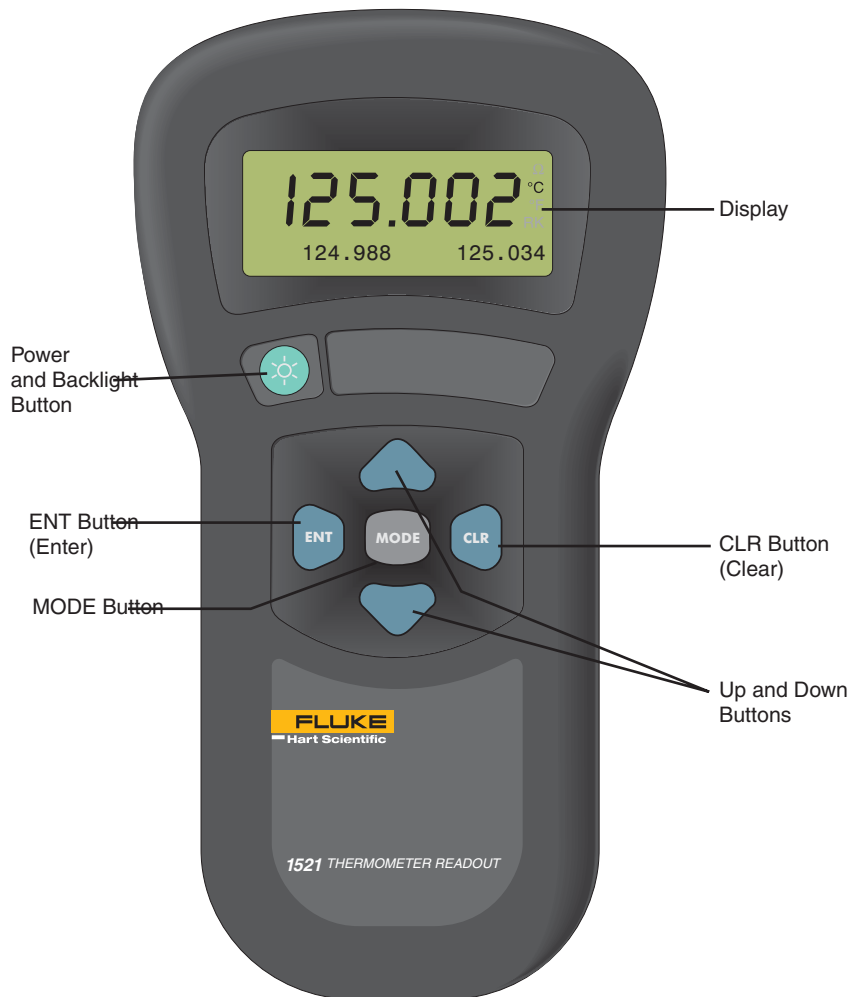

Figure 1 Front of the 1521

Display-The display shows the current temperature (or resistance) measurement on the large numeric upper portion of the display. It can also show a variety of information on the smaller alphanumeric lower portion such as minimum, maximum, hold temperatures, delta(x), and other instrument settings.

Power and Backlight button-This button turns the instrument on or off. If the power is on, pressing the button for three seconds toggles the backlight on or off (see Section 6.3). **Note: using the backlight drains the battery more quickly.**

ENT (enter) button-This button is pressed to accept changes to a setting and, in some modes, to store the most recent measurement.

CLR (clear) button-This button cancels changes to a setting and in the MIN/MAX mode resets the minimum and maximum to the last measurement.

Up and Down buttons-These buttons are used to change values and settings.

MODE button-This button advances through operating modes and programming functions (see Section 7).

5.2 Top and Side Features

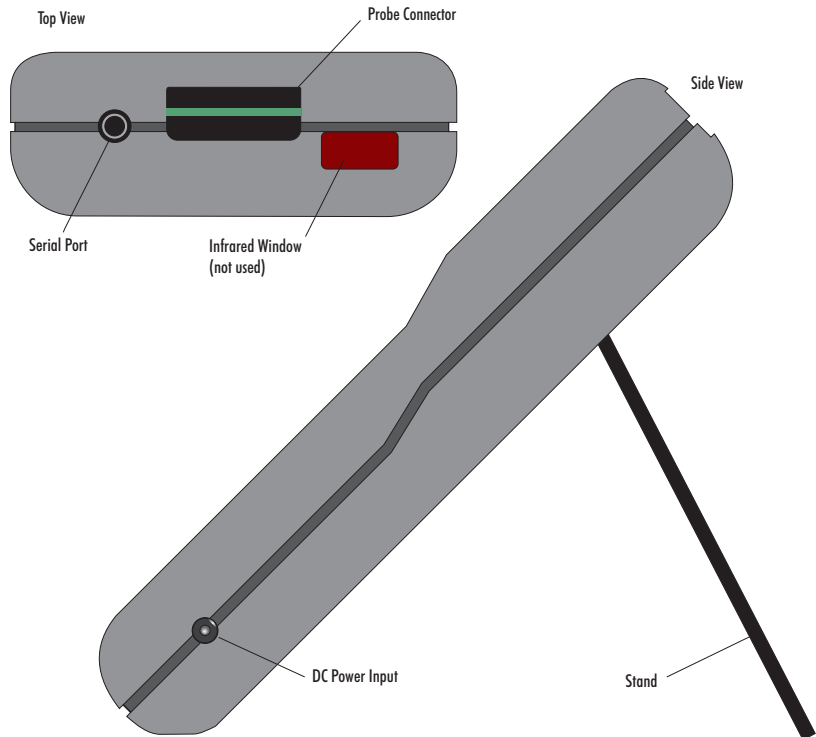

Figure 2 Top and Side View

The top and side of the 1521 feature the probe connector, DC power input, serial port, and infrared window.

Probe Connector - At the top of the thermometer is the opening where the probe connector is inserted. The probe must be connected using an INFO-CON probe connector to measure temperature (see Section 6.6).

DC Power Input-The AC adapter plugs into the DC power input to recharge the battery and to power the instrument while the battery is being charged (see Section 6.2).

Serial Port-The RS-232 serial port provides a means of connecting the 1521 to a computer or a printer using the included serial cable (see Section 8). The baud rate is fixed at 2400 baud, the linefeed is fixed to ON (all carriage returns are followed by a linefeed (ASCII decimal 10), and the duplex is fixed to Half disabling the echo.

Infrared Window-The infrared window has no functionality.

5.3 Back Features

See Figure 4 on page 19.

Stand-The stand at the back of the 1521 can be flipped down to prop up the instrument for better viewing.

Battery Compartment- Behind the stand is the compartment that contains the battery pack. The battery pack can be accessed if necessary by opening the battery cover with a small Philips screwdriver (see Section 6.1).

Serial Number Label-Also behind the stand is the serial number label that uniquely identifies the instrument.

5.4 Internal Features

The significant components inside the 1521 are described here.

Battery-The 1521 has an internal rechargeable battery pack that can be recharged by the AC adapter without removing the battery. It can be used and recharged many times. If necessary, it can be easily removed and replaced (see Section 6.1).

Micro-controller-The 1521 uses a micro-controller to control all its functions. The micro-controller manages the measurement process, retrieves measurement data from the analog-to-digital converter (ADC), places measurements and other information on the display, senses button actions, reads battery status information from the power control circuit, and handles communications through the serial port.

Power Control Circuit-The power control circuit manages the electrical power that drives all the circuits. It handles switching between the two sources of power (DC input and battery pack), regulates voltages, monitors the state of battery charge, and manages battery charging.

Analog-to-Digital Converter and Measurement Circuit-The ADC takes an analog signal produced by the probe and converts it to a digital value that can be read by the micro-controller. The ADC used in the 1521 was selected for its excellent resolution, linearity, and stability. The measurement circuit built around the ADC was carefully designed for accuracy and stability to match the ADC. The measurement circuit allows complete rejection of probe wire resistance effects that would otherwise seriously limit accuracy. Offsets from sources such as thermoelectric EMF are also completely rejected. This is done using a current reversal technique with the probe current alternating at a rate of one cycle per second. Self-heating is minimized by using low sensing currents. For PRTs the current is only 0.5 mA. For thermistors the current is only 0.005 mA.

5.5 Accessories

The 1521's accessories and their features are described here.

AC Adapter-The AC adapter recharges the internal battery pack and can also be used to supply power to operate the 1521 while the battery is being charged (see Section 6.2).

Serial Cable-The serial cable can be used to connect a computer or a printer to the 1521 through its serial port (see Section 8).

INFO-CON Connector-Hart's unique INFO-CON connector allows the probe to be easily attached and detached from the 1521. It also contains a memory device that **stores information about the probe and automatically transfers this data to the 1521 when the probe is attached**. This ensures that the settings used to measure and calculate temperature always match the probe being used (see Section 6.6).



Figure 3 INFO-CON Connector

Probe-The probe acts as the temperature sensor. Its resistance depends on its temperature. The 1521 precisely measures the resistance of the probe and uses the coefficients stored in the INFO-CON connector to calculate its temperature (see Section 6.5). The following probe options are available.

Ordering Information					
Model	Type	Range	Size	Cal Uncertainty and Repeatability	Typical Drift (1 year)
5626	Pt-100 Ohm, 4-wire	-200 to 660°C	1/4" x 12" or 15" (6.35 x 305 or 381 mm)	±0.015°C	±0.03°C
5628	Pt-25 Ohm, 4-wire	-200 to 660°C	1/4" x 12" or 15" (6.35 x 305 or 381 mm)	±0.015°C	±0.03°C
5614	Pt-100 Ohm, 4-wire	-200 to 450°C	1/4" x 12" (6.35 x 305 mm)	±0.025°C	±0.01°C
5613	Pt-100 Ohm, 4-wire	-200 to 300°C	3/16" x 6" (4.76 x 152 mm)	±0.025°C	±0.01°C
5612	Pt-100 Ohm, 4-wire	-200 to 450°C	3/16" x 9" (4.76 x 229 mm)	±0.025°C	±0.01°C
5627-6	Pt-100 Ohm, 4-wire	-200 to 300°C	3/16" x 6" (4.76 x 152 mm)	±0.035°C	±0.13°C
5627-9	Pt-100 Ohm, 4-wire	-200 to 450°C	3/16" x 9" (4.76 x 229 mm)	±0.035°C	±0.13°C
5627-12	Pt-100 Ohm, 4-wire	-200 to 450°C	1/4" x 12" (6.35 x 305 mm)	±0.035°C	±0.13°C
5610-6	10K-ohm Thermistor	0 to 110°C	1/8" x 6" (3.2 x 152 mm)	±0.02°C	±0.01°C
5610-9	10K-ohm Thermistor	0 to 110°C	1/8" x 9" (3.2 x 229 mm)	±0.02°C	±0.01°C
5611	10K-ohm Thermistor	0 to 110°C	0.07" x 0.55" (1.8 x 14 mm)	±0.02°C	±0.01°C
5611T	10K-ohm Thermistor	0 to 110°C	0.11" x 1.1" (2.8 x 28 mm)	±0.02°C	±0.01°C
5640	4K-ohm Thermistor	0 to 60°C	1/4" x 9" (6.35 x 229 mm)	±0.0015°C	±0.005°C

LogWare Software - The Model 9934 LogWare software is a one channel data acquisition software. This software can be used with your 1521 thermometer to collect and graph data.

Carrying Cases - There are two types of cases available for your 1521 thermometer. The Model 9318 case is a hard case for carrying the thermometer and a 12" probe. The Model 9321 case is a soft case with a belt clip and a probe slot.

6 General Operation

This section explains the details of the operation of the 1521 with its components and accessories.

6.1 Battery

The 1521 has a built-in nickel-metal-hydride battery pack that can power the instrument for about 18 hours before needing to be recharged. The battery will discharge much more quickly if the display backlight is used often. The battery charge remaining or the message “External Power” is shown on the display when the instrument is switched on. The battery percentages are approximate and should be used as general guidelines when determining the length of charge remaining.

The battery is recharged *in situ* (while in place) using the AC adapter that’s provided. Plug the AC adapter into an AC socket of the appropriate voltage as noted on the AC adapter (normally 115V, optionally 230V). Connect the DC plug of the adapter into the DC input of the 1521 located on the right side. The battery will be charged as necessary whether or not the instrument is switched

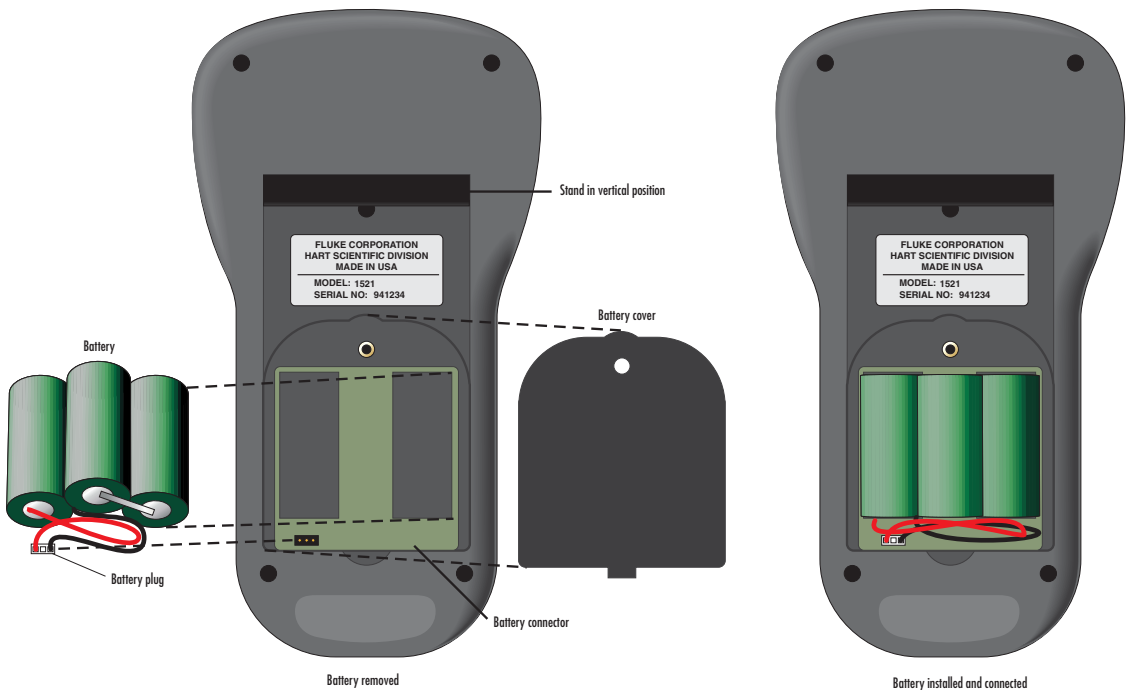

Figure 4 Battery Installation

on. The power control circuit inside the instrument manages battery charging and will stop charging the battery automatically when it's fully charged. It normally takes about four hours to fully charge the battery. The instrument can be operated while the battery is being charged.



CAUTION: DO NOT leave the AC adapter plugged in for more than 24 consecutive hours or, the battery life could be degraded.

The battery pack can be used for a minimum of 500 charge-discharge cycles before needing to be replaced. Replacement battery packs are available from the manufacturer. The battery pack can be easily removed and replaced in the field by following this procedure:

1. Power the 1521 off and unplug the AC adapter from the unit.
2. With the 1521 facing down, lift the stand to expose the battery cover (see Figure 4). Remove the battery cover screw with a small Philip's screwdriver. Place the screw in a safe place so it won't get lost. Remove the battery cover to access the battery pack.
3. Pull the battery pack out. **Note the orientation of the battery plug on the connector.** The new battery pack will be plugged in the same direction. Gently pull the battery plug off the connector.
4. Attach the polarized plug of the new battery pack onto the connector in the same direction as before (see Figure 4 on page 19). Place the battery pack in the battery compartment.
5. Close the battery cover and replace the screw.
6. Plug in the AC adapter and charge for a minimum of four hours for its initial charge.



WARNING: Used batteries must be disposed of properly. Check your local regulations for additional information. You may return used batteries to the manufacturer. Never dispose of batteries in fire as this may result in explosion with the possibility of personal injury or property damage.

6.2 DC Power Source

The DC power source provides power to charge the battery. It can also be used to power the 1521 while the battery is being charged. The AC adapter provided with the 1521 is intended to be used for these purposes. Use only the AC

adapter supplied with the instrument. The DC power source plugs into the DC power input on the right side of the 1521.

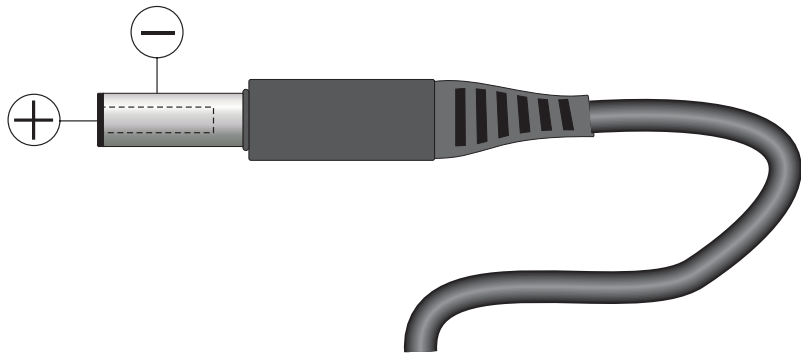

Figure 5 12V DC Power Source Polarity



WARNING: The AC adapter has circuits with high voltages inside that could present danger of electric shock or fire if exposed. If the AC adapter is damaged in any way or becomes hot, discontinue its use immediately, disconnect it from any AC supply, and have it replaced. Do not attempt to open, repair, or continue using a damaged or defective AC adapter.

6.3 Power Button

The power button controls power to the instrument and operates the backlight. The following table summarizes the power button functions.

Function	Action
Power on	Press the power button for at least two seconds when the power is off
Power off	Press the power button momentarily (1/2 second or less) when the power is on
Backlight on	Press the power button for three seconds or more when the power is on and the backlight is off
Backlight off	Press the power button for three seconds or more when the backlight is on

6.4 Display and Backlight

The display shows measurement data and other information depending on the selected mode.

The upper part of the display continually shows the most recent measurement. It uses large digits for easy viewing. A new measurement is produced and displayed every second. The unit associated with the measurement is shown in

smaller type to the right of the measurement. The possible units are degrees Celsius (C), resistance in ohms (Ω), degrees Fahrenheit (F), Kelvin (K), and degrees Rankine (R). The units can be easily changed by placing the display in the units setting mode using the **MODE** button (see Section 7.5).

The lower part of the display has various functions depending on the selected mode. It has smaller alphanumeric characters. It can be used to display minimum and maximum measurements, delta(x) measurements, or measurements stored in memory. It is also used to view and set various operating parameters. The mode is easily changed using the **MODE** button. (See details on the various modes beginning with Section 7.)

The display has a backlight that can be switched on for better viewing in dim light. The backlight is switched on and off by pressing and holding the power button for three seconds (see Section 6.3 above). **Note: The battery discharges more quickly when the backlight is used.**

6.5 Probe

The probe is used to sense temperature. The probe attaches to the 1521 using a Hart INFO-CON probe connector that plugs into the top of the instrument. **The probe connector must be properly programmed with the correct characteristics of the probe for measurements to be accurate (see Section 6.6).**

The 1521 can be used with various types of PRT and thermistor probes:

- ITS-90 calibrated 25 Ω or 100 Ω PRT
- IEC-751 or DIN-43760 PRT (RTD)
- Callendar-Van Dusen calibrated 100 Ω PRT
- YSI-400 series or equivalent 2252 Ω thermistor
- Steinhart-Hart thermistor polynomial; nominal R(25°C) 2k Ω to 100k Ω

See Section 7.8.8 for details on the various probe types and their programming. The 1521 cannot be used with thermocouples.

The 1521 can be used with probes having two, three, or four wires. Three wires allow partial compensation for wire resistance. The 1521 measures three-wire probes using the following algorithm. It measures the sensor resistance, including the lead resistance in C2. The 1521 then directly measures the resistance in the C1 lead of the sensor. The 1521 then subtracts the measured C1 lead resistance from the measured sensor resistance (including the C2 lead resistance) to obtain the sensor resistance used to calculate temperature. Note: This algorithm assumes that the lead resistance of C1 and C2 are equal. If C1 and C2 have different resistance there will be an error in the calculated sensor resistance equal to this difference. Four wires allow complete rejection of wire resistance and should be used when the best accuracy is desired. The 1521 wire setting must be set to match the actual number of wires of the probe (see Section 7.8.14).

Temperature is generally sensed at the tip of the probe. To get an accurate temperature measurement the probe sheath should be well immersed, with adequate depth and fit, into the medium to be measured.



CAUTION: *Probes are fragile devices that can be easily damaged by mechanical shock, overheating, and absorption of moisture or fluids in the wires or hub. Damage may not be visibly apparent but nevertheless can cause drift, instability, and loss of accuracy. Observe the following precautions:*

Do not allow probes to be dropped, struck, bent, or stressed.

Do not overheat probes beyond their recommended temperature range.

Do not allow any part of the probe other than the sheath to be immersed in fluid.

Do not allow the probe hub or wires to be exposed to excessive temperatures.

Keep the probe wires clean and away from fluids.

6.6 INFO-CON Connector

The probe connects to the top of the 1521 using a Hart INFO-CON connector (see Figure 3 on page 17). The probe connector will fit snugly and lock into place when it is fully inserted. The connector includes a memory device that stores the unique characteristics of the probe, allowing the instrument to measure temperature accurately. Generally, the probe will be purchased with the connector attached and programmed by the factory. Connectors can be purchased separately and installed onto probes by the user. The INFO-CON can be programmed directly from the 1521 by authorized personnel.

If it is necessary to install the INFO-CON onto a probe in the field follow the diagram below for connecting the wires of the probe to the connector terminals. Before opening the INFO-CON case, be sure to be grounded with an ESD strap to avoid damaging the memory chip. For four-wire probes, one pair of wires attaches to terminals C1 and P1 and the other pair attaches to terminals C2 and P2. (C1 and C2 source current and P1 and P2 sense the potential.) If a shield wire is present it should be connected to the GND terminal (see Figure 6).

A three-wire or two-wire probe can also be used with the 1521. A three-wire probe is connected by attaching the common wires to the C1 and P1 terminals and the other wire to the C2 and P2 terminals. The two-wire probe is connected by one wire to the C1 and P1 terminals and the other wire to C2 and P2. Again, any shield wire should be connected to the GND terminal (see Figure 6). Rec-

ognize that accuracy may be significantly degraded using a two-wire connection because of wire resistance.

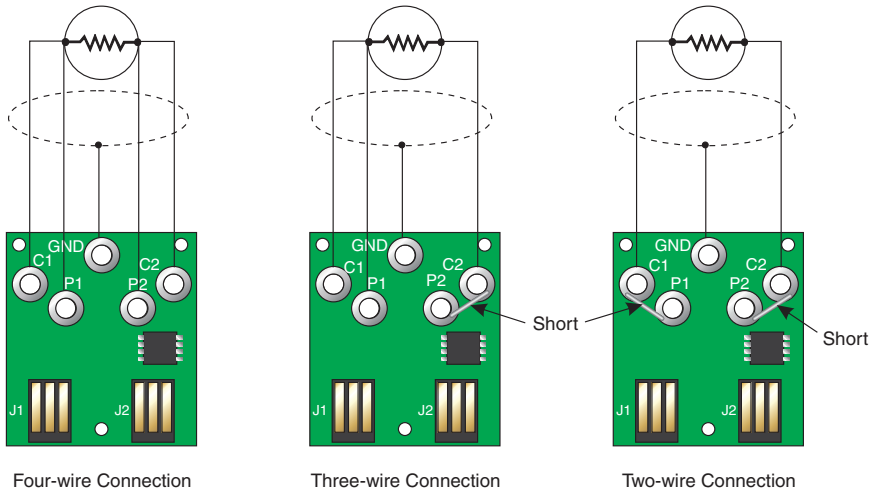

Figure 6 Probe Wiring Diagrams

7 Display Functions

The 1521 operates in any of several modes which determine what information is visible in the lower alphanumeric portion of the display. The **MODE** button changes the mode. This button can be pressed repeatedly until a desired mode is set. The various modes are listed below in the order they appear. (See Figure 7).

Blank - No data shown

Min/Max - Minimum and maximum measurements (**CLR** to reset)

Hold - Data stored in the hold registers

Delta(x) - Delta from reference measurement (**ENT** to set reference)

Units: C/Ω/F/K/R - Set the units of measurement

Rate: 00000 - Set the period for serial transmission

Resol: XXX.XXX - Set the display resolution

CAL MODE - Set probe and instrument calibration parameters (**MODE** button must be held for three seconds) See Section 7.8.

Note: Units, Rate, and Resol are temporary modes. The instrument will return to Delta(x) mode if left in one of these modes when the power is cycled.

Each of these operating modes is described in the sections that follow.

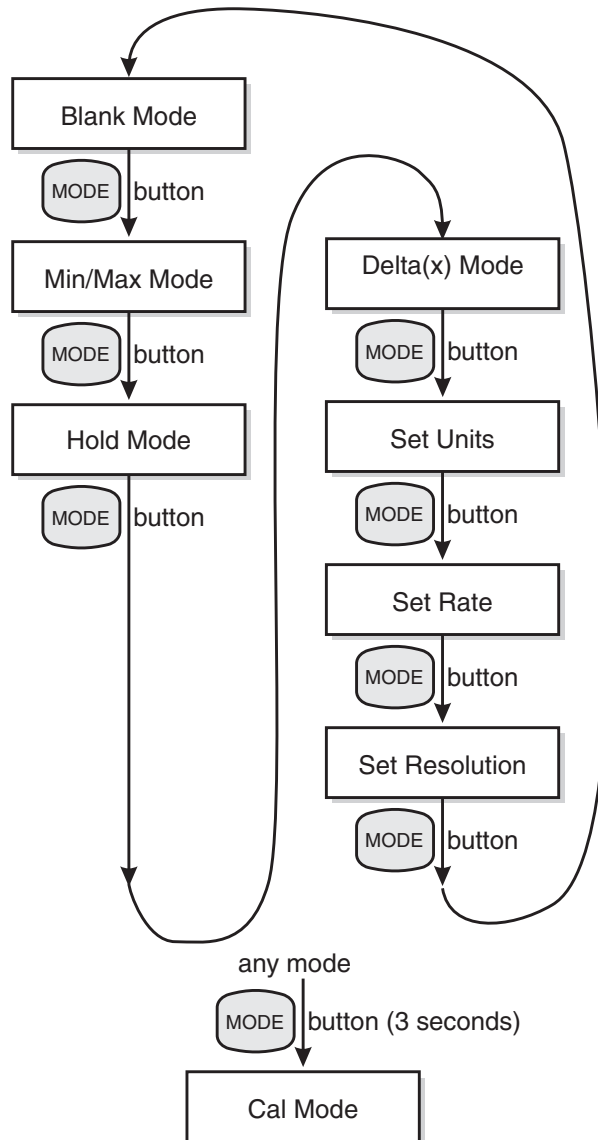

Figure 7 Operating Modes Flowchart

7.1 Blank Mode

This mode is identified by “Blank” that temporarily appears on the display.

In this mode nothing appears on the alphanumeric portion of the display. Use this mode if you are only interested in the latest measurements and want to simplify the appearance of the display.

The message “Prb cal expired”, “Mtr cal expired”, “Recharge Needed”, or “Probe is locked” may be displayed. See Section 11.1.

7.2 Min/Max Mode

This mode is identified by “Min/Max” that temporarily appears on the display.

In this mode the maximum and minimum measurements taken since the last time the function was cleared appears on the display. The minimum appears on the left and the maximum appears on the right. The resolution of the displayed values may be changed using the Resolution mode (see Section 7.7). Pressing the **CLR** button at anytime while in this mode clears the minimum and maximum values setting them to the last measurement. Both the minimum and maximum are reset to 0°C (32°F) when the instrument is powered up.

The message “Prb cal expired”, “Mtr cal expired”, “Recharge Needed”, or “Probe is locked” may be displayed. See Section 11.1.

7.3 Hold Mode

This mode is identified by “Hold” that temporarily appears on the display.

In this mode the data stored in one of the hold registers appears on the display. There are six hold registers. The resolution of the Hold register values may be changed using the Resolution Mode (see Section 7.7). The **Up** and **Down** buttons are used to select a desired hold register for viewing. The **ENT** button is used to store a measurement in the next available register.

The message “Prb cal expired”, “Mtr cal expired”, “Recharge Needed”, or “Probe is locked” may be displayed. See Section 11.1.

7.4 Delta(x) Mode

This mode is identified by “Delta(x)” that temporarily appears on the display.

In this mode the delta between the measurement and a previously stored reference value appears on the right side of the display. The reference value appears on the left. The resolution of the reference value may be changed using the Resolution mode (see Section 7.7) if necessary. The **ENT** button stores the present measurement as the reference value.

The message “Prb cal expired”, “Mtr cal expired”, “Recharge Needed”, or “Probe is locked” may be displayed. See Section 11.1.

7.5 Units

This mode is identified by “Units: C/Ω/F/K/R” that appears on the display.

This mode allows you to select the unit of measurement: C for degrees Celsius, Ω for resistance in ohms, F for degrees Fahrenheit, K for Kelvin, and R for Rankine. The **Up** and **Down** buttons are used to select one of the displayed units. The underline cursor indicates which of the units is selected. The **ENT** button stores the selection. If the **MODE** button or **CLR** button is pressed without pressing **ENT** the unit remains unchanged. Once the unit is selected, subsequent measurements appear in that unit. **The Min/Max and Delta(x) values are automatically converted when changing to C, K, F, or R units.**

When measuring in units of ohms, make sure that the appropriate probe type has been selected in the Cal Mode menu. For example, to measure a sensor between 0 and 400 ohms, set the units to ohms and select the probe type "CVD". To measure a sensor between 400 and 500K ohms, set the units to ohms and select the probe type "THERM".

7.6 Rate

This mode is identified by “Rate: 00000” that appears on the display.

This mode allows you to set the samples that are transmitted through the serial port. The sample for a 2-wire and a 4-wire probe is approximately one second and for a 3-wire probe is approximately two seconds. For example, if the rate is set to 2, every other sample is sent through the serial interface. **Note:** If the probe wire is set to 3, the time between samples is twice as long. A value of 0 disables transmission. The **Up** and **Down** buttons are used to increase or decrease the value for the underlined digit. The **ENT** button moves to the next digit. If the **ENT** button is pushed when the *last digit is underlined*, the setting is stored. If the **MODE** button or **CLR** button is pressed, the value remains unchanged. Once the value is set, measurements are transmitted through the serial port at the given interval.

7.7 Resolution

This mode is identified by “Resol: XXX.XXX” that appears on the display.

This mode allows you to set the resolution of measurements to one, two, or three digits after the decimal point. The **Up** and **Down** buttons are used to increase or decrease the resolution setting. The **ENT** button stores the setting. If the **MODE** button or **CLR** button is pressed, the setting remains unchanged. Once the resolution is set, measurements are displayed and transmitted from the serial port at the given resolution if possible. The resolution may be reduced if necessary for large values of temperature or resistance.

7.8 CAL MODE

The calibration menu contains functions for setting probe and instrument calibration parameters. If a probe parameter is changed, the probe parameter is uploaded into the INFO-CON probe connector when the CAL MODE is exited or after scrolling through the entire menu. Always check to insure that the parameters have been written to the INFO-CON connector by disconnecting the probe or by turning the 1521 off and on.

The calibration menu is entered by pressing and holding the **MODE** button for three seconds. “CAL MODE” appears on the display. Press the **ENT** button to advance. Press the **MODE** button while in the calibration menu to exit and to advance to the display mode that follows the display mode that was active before the CAL Mode was entered.

The functions contained in the CAL Mode are listed below in the order they appear. In any of the functions the **ENT** button stores the displayed value or selection and advances to the next function. The **CLR** button can be used to cancel changes to a value or selection and skip to the next function. Use the **ENT** button to move from Mtr Due to Prb Due and then to Time. Use the **CLR** button to quickly advance through the remaining functions. Many of the functions are in the passcode protected part of the CAL Mode. You must enter the correct passcode to reach them.

Mtr Due - View the date the instrument is due for calibration

Prb Due - View the date the probe is due for calibration

Time - View and set the real-time clock time-of-day

Passcode - Enter the passcode to advance to the protected functions

Date - View and set the real-time clock date

Probe Lock - Lock or unlock operation of the unit with the current probe only

Prb # - Set the probe serial number

Prb Type - Select the probe type and temperature calculation

R(.01) [ITS-90 only] - Sets the R(273.16K) probe coefficient

a [ITS-90 only] - Set the a5, a6, a7, a8, a9, a10, or a11 probe coefficient

b [ITS-90 only] - Set the b5, b6, b7, b8, or b9 probe coefficient

c [ITS-90 only] - Set the c6, or c7 probe coefficient

d [ITS-90 only] - Set the d probe coefficient

a4 [ITS-90 only] - Set the a4 or a5 probe coefficient

b4 [ITS-90 only] - Set the b4 or b5 probe coefficient

R(0) [CVD only] - Set the R0 probe coefficient

Alpha [CVD only] - Set the alpha probe coefficient

Delta [CVD only] - Set the delta probe coefficient

Beta [CVD only] - Set the beta probe coefficient

b0 [Therm only] - Set the b0 probe coefficient

b1 [Therm only] - Set the b1 probe coefficient

b2 [Therm only] - Set the b2 probe coefficient

b3 [Therm only] - Set the b3 probe coefficient

Probe Wires - Set the number of wires of the probe

PCal - Set the probe calibration date

PDue - Set the probe calibration due date

Filter - Set the digital filter time constant

MCal - Set the instrument calibration date

MDue - Set the instrument recalibration due date

CAL1 - Set the 0 to 400 Ω instrument calibration parameter

CAL2 - Set the 400 Ω to 500 k Ω instrument calibration parameter

The calibration functions are described in detail in the following subsections.

7.8.1 Mtr Due

This function displays the date the 1521 is due for calibration. The date cannot be changed with this function.

7.8.2 Prb Due

This function displays the date the probe is due for calibration. The date is stored in the INFO-CON probe connector. The date cannot be changed with this function.

7.8.3 Time

This function displays and sets the time of day. The time is always set, displayed, or printed in 24-hour format. To set each time segment use the **Up** and **Down** buttons. Use the **ENT** button to move between time segments and to save the changed values. The **CLR** button moves to the next function.

7.8.4 Passcode

All functions below this function are protected by a pass-code so that only authorized users can access them. The passcode must be entered correctly to continue. If the passcode is entered incorrectly or the **MODE** or **CLR** buttons are pressed, the message "Invalid Passcode" is displayed and the instrument is returned to the next display mode after the display mode that was active before the CAL Mode was entered.

Each individual instrument has its own unique passcode. The passcode number is given on a notice provided with this instrument. The equipment manager is responsible for keeping the passcode number stored in a proper location and

ensuring that it is not lost or forgotten. If necessary the passcode can be re-stored by contacting the manufacturer. To enter the passcode use the **Up** and **Down** buttons to set each digit of the passcode and the **ENT** button to move to the next digit on the right. Press **ENT** twice when all digits are entered to move to the next function. If the passcode is entered correctly the next function in the CAL Mode will appear.

7.8.5 Date

This function displays the present date and allows it to be changed. This function is placed in the passcode protected part of the CAL Mode since the calibration due warning messages depend on the present date as well as the stored due dates. Use the **Up** and **Down** buttons to set each date segment and the **ENT** button to move between the date segments. Press **ENT** when all digits are entered to save the changed values. The **CLR** button moves to the next function.

7.8.6 Probe Lock

This function locks or unlocks operation of the unit with the presently connected probe only. If probe lock is set to ON, the instrument can only be used to display temperature with the probe attached when probe lock was set ON. If probe lock is ON and a different probe is attached the instrument will display the serial number of the connected probe, 'PRT: xxxxxxxxxx', and then the message "Probe is locked". Measuring will be disabled. If probe lock is OFF the instrument can be used with any probe. To lock the instrument with a new probe, set probe lock OFF, attach the new probe, and then set probe lock ON again. *Probe lock ON also disables access to the probe parameters that follow in the menu.* The probe parameters, beginning with the probe serial number, will only appear in the menu if probe lock is OFF. To set probe lock use the **Up** and **Down** buttons to select ON or OFF and press the **ENT** button to store and continue.

7.8.7 Prb

This function displays the serial number of the probe and allows it to be set. **The probe serial number is stored in the INFO-CON probe connector.** Use the **Up** and **Down** buttons to set each digit and the **ENT** button to move to the next digit on the right. Press **ENT** when all digits are entered.

7.8.8 Prb Type

This function specifies the type of probe and its characterization. It allows the 1521 to use the appropriate algorithm to calculate temperature from the measured resistance of the probe. The functions that follow the probe conversion function for setting probe characterization coefficients depend on the selected probe type. The table below lists the probe types and the corresponding coefficients.

Probe Type	Description	Coefficients
------------	-------------	--------------

ITS-90	PRTs calibrated to ITS-90	R(.01), a, b, c, d, a4, and b4
IEC751	PRTs (RTDs) conforming to IEC-751	none
CVD	PRTs characterized by the Callendar-Van Dusen equation	R0, Alpha, Delta, and Beta
YSI400	Thermistors matching the YSI-400 series	none
THERM	Thermistors characterized by the thermistor polynomial	b0, b1, b2, and b3

Each of the conversion options is explained in the following sections along with their associated coefficients, if they have any. The probe type and associated coefficients are stored in the INFO-CON probe connector. Use the **Up** and **Down** buttons to select the probe type and the **ENT** button to store and continue.

Each of the coefficients that follow the probe type, if there are any, are set in the usual way. Use the **Up** and **Down** buttons to set each digit and the **ENT** button to move to the next digit to the right. Press **ENT** when all digits are entered.

7.8.9 ITS-90

The ITS-90 type is for PRTs calibrated and characterized using the *International Temperature Scale of 1990* equations. This type of probe generally has excellent accuracy (0.005 to 0.025°C), a wide operating range (–180°C to 420°C or higher), but may be rather expensive. The coefficients that appear when ITS-90 is selected are “R(.01)”, “a”, “b”, “c”, “d”, “a4”, and “b4”. These should be set to the coefficient values that appear on the PRT calibration certificate according to the following table.

Unused coefficients must be set to 0.

1521 Coefficients	Certificate Value
R(.01)	Rtpw
a	a5, a6, a7, a8, a9, a10, or a11
b	b5, b6, b7, b8 or b9
c	c6 or c7
d	d
a4	a4 or a5
b4	b4 or b5

Consider the following examples.

Example 1:

A PRT was calibrated to ITS-90 and its calibration certificate states values for coefficients R(273.16K), a4, b4, a8, and b8. Set the 1521 coefficients to the certificate values as follows.

1521 Coefficients	Certificate Value
R(.01)	R(273.16K)
a	a8
b	b8
c	0.0
d	0.0
a4	a4
b4	b4

Example 2:

A PRT was calibrated to ITS-90 and its calibration certificate states values for coefficients R(273.16K), a5, and b5. Set the 1521 coefficients to the certificate values as follows.

1521 Coefficients	Certificate Value
R(.01)	R(273.16K)
a	a5
b	b5
c	0.0
d	0.0
a4	a5
b4	b5

7.8.10 IEC751

The IEC-751 probe type is for standard PRTs (RTDs) conforming to the IEC-751 or DIN-43760 standards. This type of probe is generally low cost and has a wide operating range (-180°C to 420°C or higher), but has limited accuracy (0.15°C to 4°C). There are no user programmable coefficients associated with this probe type.

7.8.11 CVD

The CVD (Callendar-Van-Dusen) type is used with PRTs that have unique calibration coefficients or do not match the IEC-751 specification. This type of probe is generally low cost, has a wide operating range (-180°C to 420°C or

higher), and has moderate accuracy (0.05°C to 1°C). This type uses the Callendar-Van Dusen equation to calculate temperature from resistance:

$$r(t[^\circ\text{C}]) = \begin{cases} R_0 \left\{ 1 + \alpha \left[t - \delta \frac{1}{100} \left(\frac{t}{100} - 1 \right) \right] \right\} & t \geq 0 \\ R_0 \left\{ 1 + \alpha \left[t - \delta \frac{t}{100} \left(\frac{t}{100} - 1 \right) - \beta \left(\frac{t}{100} - 1 \right) \left(\frac{t}{100} \right)^3 \right] \right\} & t < 0 \end{cases}$$

The coefficients R_0 , α , δ , and β can be set by the user using the functions "R0", "Alpha", "Delta", and "Beta" respectively. When editing "Alpha", there is an assumed exponent of 10^{-3} (i.e. 3.8500 is actually 0.0038500).

7.8.12 YSI-400

The YSI-400 type is for 2252Ω thermistors matching the characteristics of the YSI-400 series of thermistors. This type of probe generally is low cost, has a limited operating range (−40°C to 150°C), good accuracy (0.1°C to 0.4°C), and excellent resolution (0.002°C). There are no user programmable coefficients associated with this probe type. Temperature is converted from resistance based upon a standard YSI-400 table resident in the instrument.

7.8.13 THERM

The THERM thermistor type is for thermistors that have unique calibration coefficients or do not match the YSI-400 specification. This type of probe generally has moderate cost, a limited operating range (−40°C to 100°C), excellent accuracy (0.005°C to 0.02°C) and excellent resolution (0.002°C). This type uses the Steinhart-Hart equation in the following form:

$$R(T[K])[\Omega] = \exp[b_0 + b_1 T^{-1} + b_2 T^{-2} + b_3 T^{-3}]$$

The coefficients b0 through b3 are usually found on the calibration certificate of the probe. These coefficients are set with the functions "b0", "b1", "b2", and "b3". In some cases the equation is used without the b2 term. For this case, the "b2" coefficient should be set to 0. Consider the following examples.

Example 1:

A thermistor has coefficients for the equation $\ln(R)$ as a function of T given as a, b, c, and d. Set the 1521 coefficients to the certificate values as follows:

1521 Coefficients	Certificate Value
b0	a
b1	b
b2	c
b3	d

Example 2:

A thermistor has coefficients for the equation $\ln(R)$ as a function of T given as a , b , and c . Set the 1521 coefficients to the certificate values as follows:

1521 Coefficients	Certificate Value
b0	a
b1	b
b2	0.0
b3	c

7.8.14 Probe Wires

This function sets the number of connecting wires in the probe. The probe wires setting is stored in the INFO-CON connector. The 1521 can be used with probes that have two, three, or four wires. Three wires connecting the probe sensor instead of two allows the 1521 to partially cancel measurement error due to the resistance of the wires. With four wires the 1521 can completely cancel the error. The internal measurement circuit is configured differently depending on the number of wires. **Important—The 1521 will try to calculate a measurement even if the wire settings are incorrect. Therefore, the Probe Wires setting must match the actual number of wires or loss of accuracy will result.** Use the **Up** and **Down** buttons to set the value and press the **ENT** button to store and continue.

7.8.15 PCal

This function shows the date the probe was calibrated and allows it to be set. The date is stored in the INFO-CON connector and is used simply for reference. Use the **Up** and **Down** buttons to set each date segment and the **ENT** button to move to the next date segment to the right. Press **ENT** when the date is correctly entered. Press **CLR** to move to the next function without changing the date.

7.8.16 PDue

This function shows the date the probe is due for calibration and allows it to be set. The date is stored in the INFO-CON connector. The probe due date is regularly checked against the present date and if the calibration has expired the user is alerted with the message “Prb cal expired”. This message only disappears when the probe is recalibrated and the probe calibration due date is set to a future date. To set the date, use the **Up** and **Down** buttons to set each date segment and the **ENT** button to move to the next date segment to the right. Press **ENT** when the date is correctly entered. Press **CLR** to move to the next function without changing the date.

Note: Probe parameters are uploaded to the INFO-CON connector at this point.

7.8.17 Filter

The digital filter helps to smooth variations in the measurements and improve resolution. A negative effect of filtering is that it tends to slow the response to changes in temperature. You can increase the filter time constant to further improve accuracy and resolution or decrease the time constant to reduce the response time. Valid values are any number between 0.0 and 60.0 seconds. A value of 0.0 disables the filter. The default is 0.0. Use the **Up** and **Down** buttons to set the value and press the **ENT** button to store and continue. Press **CLR** to move to the next function without changing the filter.

7.8.18 MCal

This function shows the date the 1521 was calibrated and allows it to be set. The date is used simply for reference. Use the **Up** and **Down** buttons to set each date segment and the **ENT** button to move to the next date segment on the right. Press **ENT** when the date is correctly entered. Press **CLR** to move to the next function without changing the date.

7.8.19 MDue

This function shows the date the 1521 is due for calibration and allows it to be set. The meter calibration due date is regularly checked against the present date and if the calibration has expired the user is alerted with the message "Mtr cal expired". The message will only disappear when the 1521 is recalibrated and the meter calibration due date is set to a future date. To set the meter calibration due date use the **Up** and **Down** buttons to set each date segment and the **ENT** button to move to the next date segment to the right. Press **ENT** when the date is correctly entered. Press **CLR** to move to the next function without changing the date.

7.8.20 CAL1 and CAL2

The CAL1 and CAL2 meter calibration parameters calibrate the 0 to 500 Ω measurement range and the 0 to 500 k Ω measurement range respectively. These parameters directly affect the accuracy of the 1521 and are only to be altered by an authorized, qualified technician as part of a regular instrument calibration operation. Refer to the calibration procedure in Section 9. Use the **Up** and **Down** buttons to set the value and press the **ENT** button to store and continue. Press **CLR** to move to the next function without changing the date.

8 Communications Interface

Remote communications allows an external device, such as a computer, to communicate with the 1521 to obtain measurement data and control its operation. Communication is accomplished with various commands issued to the 1521 through the RS-232 serial port.

8.1 RS-232 Connection

The three-conductor jack for the serial port is located on the top of the 1521 near the probe connector. One serial cable is included with the 1521. Additional or longer cables, of three meters or less, can be constructed by following the wiring diagram shown in Figure 8. **Note: The TxD line on one side connects to the RxD line on the other and vice-versa.** To reduce the possibility of electrical interference, the serial cable should be shielded with low resistance between the connector and the shield. It should not be much longer than is necessary. The protocol for serial communications is 8 data bits, 1 stop bit, and no parity. Use no flow control. The baud rate is fixed at 2400, the linefeed to

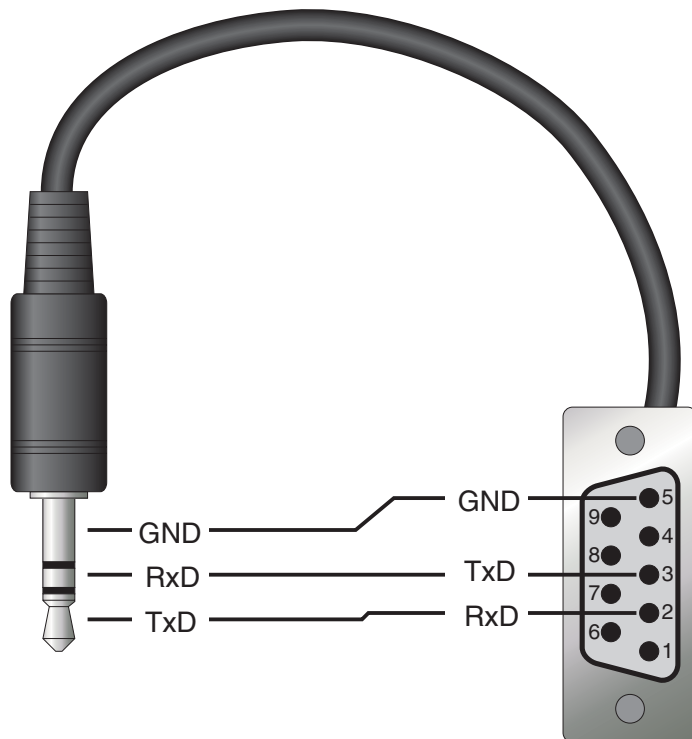

Figure 8 RS-232 Wiring

ON (all carriage returns are followed by a linefeed (ASCII decimal 10)), and the duplex to HALF disabling echo.

The serial port can be used to transmit measurements to a computer or printer. It can also be used to change settings of the 1521 from a computer or interface with software. A full list of commands follows in Section 8.2.

Commands sent to the 1521 must end with an EOS character which is a carriage return (ASCII decimal 13) or linefeed character (ASCII decimal 10). Commands can be sent with upper or lower case letters. Data returned from the 1521 ends with a carriage return and a linefeed.

8.2 Communication Command List

8.2.1 Primary Commands

The following group of commands read or set various functions.

Description	Command	Example	Response Format	Response Example	Range
Read measurement, extended format	t[emperature]	t	t: 999.999 {C, O, F, R, or K} mm-dd-yyyy hh:mm:ss	t: 125.745 C 03-01-1999 15:49:15	
Read measurement, simple format	f[etch?] rea[d?] me[asure?]	fetch? read? meas?	t: 999.999 {C, O, F, R, or K}	t: 25.587 C	
Read minimum	m[inimum]	min	min: 999.999 {C, O, F, R, or K}	min: -14.653 C	
Read maximum	ma[ximum]	max	max: 999.999 {C, O, F, R, or K}	max: 416.781 C	
Clear minimum and maximum	cl[ear]	clear			
Read a hold register	h[ld]<n>	hld6	hld<n>: 999.999 {C, O, F, R, or K}	hld6: 26.553 C	<n> can be 1 to 6
Store present measurement to next available hold register	s[tore]	store			
Read delta(x) measurement	dx	dx	dx: 999.999 {C, O, F, R, or K}	dx: -0.118 C	
Set delta(x) reference to present measurement	sd[x]	sd			
Read unit	u[nit]	u	u: {C, O, F, R, or K}	u: C	
Set unit	u[nit]=C/O/F/K/R	u=C			C, O, F, K, R
Read serial sample rate	sa[mple]	sa	sa: 9	sa: 10	
Set serial sample rate	sa[mple]=s	sa=60			0 to 10,000
Read resolution digits	re[solution]	res	res: 9	res: 3	

Description	Command	Example	Response Format	Response Example	Range
Set resolution digits	re[resolution]=n	res=1			1 to 3
Read time	ti[me]	time	ti: hh:mm:ss	ti: 16:23:45	
Set time Note: You must set hours, minutes, and seconds for the time to be set correctly.	ti[me]=hh:mm:ss	ti=08:15:00			00:00:00 to 23:59:59
Read identification information	*[idn?]	*idn?	<manufacturer>, <model>, <serial number>, <firmware version>	Idat, 1521, 95001,	
Read model and firmware version	*v[ersion]	*ver	ver.<model>, <firmware version>	ver.1521, 2.11	
Legend:	[]	Optional Command data			
	{ }	Returns either information			
	n	Numeric data supplied by user			
	9	Numeric data returned to user			
	x	Character data returned to user			

8.2.2 Calibration Commands

The following group of commands directly or indirectly affect the accuracy of the instrument. These commands should only be used by qualified, authorized personnel. **Calibration parameters can only be changed if protection is disabled by entering the proper pass-code using the command *pas= dddd.** Entering an invalid passcode or cycling the power re-establishes protection of the calibration parameters. The parameters can be read without disabling the passcode protection.

Description	Command	Example	Response Format	Response Example	Range
Unprotect calibration parameters with the pass-code	*pas[scode]=nnnnn	*pas=12345			
Read date	da[te]	date	da: yyyy-mm-dd	da: 1999-03-28	
Read passcode protection state	*pas	*pas	ps:9	ps:0	0 or 1
Set date	da[te]=yyyy-mm-dd	da=1999-03-28			1999-01-01 to 2100-12-31
Read probe serial number	se[rial]	ser	ser: xxxxxxxxxx	ser: 100231A	
Set probe serial number	se[rial]=xxxxxxxx	ser=001			0 to 9, A to Z, -, /
Read probe type	p[robe]	pr	pr: {ITS-90, IEC751, CVD, YSI400, THERM}	pr: ITS-90	

1521 Handheld Thermometer Readout
User's Guide

Description	Command	Example	Response Format	Response Example	Range
Set probe type	p[robe]=IT[S-90]/ IE[C751]/ C[VD]/ Y[SI400]/ T[HR]	pr			ITS-90, IEC751, CVD, YSI400, THERM
Read ITS-90 R(.01) or CVD R0	r[0]	r0	r0: 9999.999	r0: 100.035	
Set ITS-90 R(.01) or CVD R0	r[0]=n	r0=100.106			1 to 900
Read ITS-90 coefficient	a/b/c/d/a4/b4	a	{a/b/c/d/a4/b4}: -9.999999E-99	a: -2.8644101E-5	
Set ITS-90 coefficient	a/b/c/d/a4/b4=n	a=-2.8644E-5			1.0 to 9.9e-18
Read CVD coefficient	al[pha]/de[lt]/be[ta]	al	{al/de/be}: 9.99999999	al: 0.0038123	
Set CVD coefficient	al[pha]/de[lt]/be[ta]=n	al=0.0038512			E+/-18
Read THERM thermistor coefficient	b0/b1/b2/b3	b3	{b0/b1/b2/b3}: 9.999999e-99	b3: -9.944070e-12	
Set THERM thermistor coefficient	b0/b1/b2/b3=n	b3=-9.944E-12			E+/-18
Read probe wires	wi[res]	wi	wi: 9	wi: 4	
Set probe wires	wi[res]=2/3/4	wi=4			2,3,4
Read probe calibration date	pc[al]	pcal	pc: yyyy-mm-dd	pc: 1999-03-28	
Set probe calibration date	pc[al]=yyyy-mm-dd	pc=1999-03-28			1999-01-01 to 2100-12-31
Read probe due date	pd[ue]	pdue	pd: yyyy-mm-dd	pd: 1999-03-28	
Set probe due date	pd[ue]=yyyy-mm-dd	pd=1999-03-28			1999-01-01 to 2100-12-31
Read filter	fi[ltér]	fi	fi: 99.99999	fi: 0.5	
Set filter	fi[ltér]=n	fi=0			0.0 to 60.0
Read low range calibration	*c1	*c1	c1: 99.999	c1: -0.0121	
Set low range calibration	*c1=n	*c1=-0.012			-1.999 to 1.999
Read high range calibration	*c2	*c2	c2: 9999.9	c2: -0.9	
Set high range calibration	*c2=n	*c2=-0.9			-1980.0 to 1980.0
Read meter calibration date	mc[al]	mcal	mc: yyyy-mm-dd	mc: 1999-03-28	
Set meter calibration date	mc[al]=yyyy-mm-dd	mc=1999-03-28			1999-01-01 to 2100-12-31
Read meter due date	md[ue]	mdue	md: yyyy-mm-dd	: 1999-03-28	
Set meter due date	md[ue]=yyyy-mm-dd	md=1999-03-28			1999-01-01 to 2100-12-31

Legend: [] Optional Command data
 {} Returns either information

Description	Command	Example	Response Format	Response Example	Range
	n	Numeric data supplied by user			
	9	Numeric data returned to user			
	x	Character data returned to user			

9 Calibration

The 1521 should be calibrated at regular intervals to ensure that it continues to measure with proper accuracy. Calibration should only be done by qualified, authorized personnel.

9.1 Required Equipment

The following items are required to test and calibrate the 1521:

- 0 Ω four-wire resistor (short)
- 25 Ω four-wire resistor, uncertainty within 20 ppm ($\pm 0.0005\Omega$)
- 100 Ω four-wire resistor, uncertainty within 20 ppm ($\pm 0.002\Omega$)
- 400 Ω four-wire resistor, uncertainty within 20 ppm ($\pm 0.008\Omega$)
- 4 k Ω four-wire resistor, uncertainty within 50 ppm ($\pm 0.2\Omega$)
- 10 k Ω four-wire resistor, uncertainty within 50 ppm ($\pm 0.5\Omega$)
- 40 k Ω four-wire resistor, uncertainty within 50 ppm ($\pm 2\Omega$)
- 100 k Ω four-wire resistor, uncertainty within 50 ppm ($\pm 5\Omega$)
- 500 k Ω four-wire resistor, uncertainty within 75 ppm ($\pm 37.5\Omega$)

Each resistor must be attached with an INFO-CON probe connector. The 25 Ω , 100 Ω , and 400 Ω resistors must be programmed with the CVD probe type with units set to ohms. The 4 k Ω , 10 k Ω , 40 k Ω , 100 k Ω , and 500 k Ω resistors must be programmed with the THERM probe type with units set to ohms.

9.2 Calibration Procedure

Calibration requires adjustment of the CAL1 and CAL2 parameters at 100 Ω and 10 k Ω respectively (see Section 7.8.20). The calibration parameters can be accessed from the front panel by pressing the **MODE** button and holding it for three seconds, releasing it, then pressing the **ENT** button (see Section 7.8). You must enter the pass-code to continue (see Section 7.8.4). The step-by-step procedure is as follows:

1. Connect the 100 Ω resistor. Adjust the CAL1 parameter by subtracting the measured error. For example, if the resistor is exactly 100.000 Ω and the 1521 measures 100.029 Ω , CAL1 should be adjusted by subtracting 0.029 from the current value of CAL1.
2. Verify the accuracy at 0 Ω , 25 Ω , 100 Ω , and 400 Ω .
3. Connect the 10 k Ω resistor. Adjust the CAL2 parameter by subtracting the measured error. For example, if the resistor is exactly 10.0000 k Ω and the 1521 measures 10.0029 k Ω , CAL2 should be adjusted by subtracting 2.9 from the current value of CAL2.

4. Verify the accuracy at 0Ω , $4k\Omega$, $10k\Omega$, $40k\Omega$, $100k\Omega$, and $500k\Omega$.
5. Set the meter calibration date to the present date (see Section 7.8.18).
6. Set the meter due date to one year from the present date (see Section 7.8.19).

10 Maintenance

- This instrument has been designed with the utmost care. Ease of operation and simplicity of maintenance have been a central theme in the product development. Therefore, with proper care the instrument should require very little maintenance. Avoid operating the instrument in oily, wet, dirty, or dusty environments.
- If the outside of the instrument becomes soiled, it may be wiped clean with a damp cloth and mild detergent. Do not use harsh chemicals on the surface which may damage the LCD or the plastic outside shell.
- If a hazardous material is spilt on or inside the equipment, the user is responsible for taking the appropriate decontamination steps as outlined by the national safety council with respect to the material.
- Before using any cleaning or decontamination method except those recommended by Hart, users should check with an Authorized Service Center to be sure that the proposed method will not damage the equipment.
- If the AC adapter becomes damaged, have it replaced immediately. Never disassemble the AC adapter or attempt to repair it.
- If the instrument is used in a manner not in accordance with the equipment design, the operation of the thermometer may be impaired or safety hazards may arise.

11 Troubleshooting

In case you run into difficulty while operating the 1521, this section provides some suggestions that may help you solve the problem. Below are several situations that may arise followed by possible causes of the problem and suggested actions you might take.

11.1 An Error Message Is Displayed

The following table lists possible error messages, their causes, and suggested actions.

Problem	Solution
"Recharge Needed"	The battery is low and needs to be recharged. When this message first appears the user has approximately 30 minutes of charge left. If the battery is not recharged, the 1521 continues to operate until the battery drops below 0% and then automatically shuts itself off after displaying the error message.
"No Probe"	The display shows ' - - - - - '. The instrument is unable to detect that a probe is connected. Check that a probe with a properly programmed INFO-CON connector is attached.
"Probe is locked"	The incorrect probe is attached. The meter is set to accept only the probe with the given serial number. Attach the correct probe or have the instrument properly programmed for the new probe.
"Prb cal expired"	The probe calibration has expired. Have the probe calibrated and the calibration due date reset.
"Mtr cal expired"	The meter calibration has expired. Have the instrument calibrated and the calibration due date reset.
"Invalid Passcode"	The passcode entered was not correct. Check the passcode on the Pass-code Notice sent with the instrument.
The instrument display is blank when normally it should show measurements.	Make sure the instrument has power, either from the batteries or the AC adapter. Verify that the initialization information appears on the display when the power is switched on. Check to make sure that a probe is properly connected. Check to make sure that the probe is programmed properly.

Problem	Solution
<p>While attempting to measure resistance the display shows an incorrect value.</p>	<p>Poor or incorrect connection of the probe. A common mistake is to connect the wires of the probe to the wrong terminals. Check the wiring carefully (see Figure 6).</p> <p>Open, shorted, or damaged sensor or lead wires. Check the resistance across the sensor using a handheld DMM. Also check the resistance between common pairs of leads. Check to make sure there is no conductivity between any of the leads and the probe sheath. Use a good-quality sensor to avoid errors caused by drift, hysteresis, or insulation leakage.</p> <p>Stem conduction error. Make sure the stem of the probe is immersed in the medium with adequate depth and a tight fit.</p> <p>Electrical interference. Intense radio-frequency radiation near the 1521 or the probe can induce noise into the measurement circuits resulting in erratic readings. Try eliminating the source of interference or moving the 1521 to a different location. A well-grounded, shielded cable should be used for the probe.</p>
<p>Memory Check Error</p>	<p>Memory Error. A non-critical parameter is corrupt in memory. The non-critical parameters are Units, Rate, Resolution, Filter, and serial port settings. Press any key and the display reads "Check Settings". Press any key again to resume normal operation. Check your current settings for the specific parameters that were set.</p> <p>Memory Recover X. A critical parameter is corrupt and the 1521 can recover the correct value for that parameter. The critical parameters are CAL1, CAL2, Passcode, Meter Due Date, Meter Cal Date, and Serial Number. Press any key and the display reads "Check Settings". Press any key again to resume normal operation. Also, check non-critical settings as in the Memory Error above. The number following the message is used by authorized technicians.</p> <p>Memory Invalid! A critical parameter is corrupt and the 1521 cannot recover the correct value for the parameter. The critical parameters are CAL1, CAL2, Passcode, Meter Due Date, Meter Cal Date, and Serial Number. Press any key and the display reads "Contact Factory". Contact an Authorized Service Center (see Section 1.3) for assistance in guiding you through the process of reentering critical parameters.</p> <p>Note: The parameters stored in the INFO-CON, Probe Wires, Probe Type, Probe Parameters, are not checked by the meter during memory testing.</p>

11.2 CE Comments

11.2.1 EMC Directive

Hart Scientific's equipment has been tested to meet the European Electromagnetic Compatibility Directive (EMC Directive, 89/336/EEC). The Declaration of Conformity for your instrument lists the specific standards to which the unit was tested.

The instrument was designed specifically as a test and measuring device. Compliance to the EMC directive is through IEC 61326-1 *Electrical equipment for measurement, control and laboratory use – EMC requirements (1998)*.

As noted in the IEC 61326-1, the instrument can have varying configurations. The instrument was tested in a typical configuration with shielded, grounded probe and RS-232 cables. Emissions may, in non-typical applications, exceed the levels required by the standard. It is not practical to test all configurations, as the manufacturer has no control over the probes the user may connect to the instrument.

11.2.1.1 Immunity Testing

The instrument was tested to the requirements for industrial locations. This allows the instrument to be used in all types of locations from the laboratory to the factory floor. Criterion B was used for Radiated RF (IEC 61000-4-3) and Conducted RF (IEC 61000-4-6). Therefore, the operation of the instrument may be affected by excessive electromagnetic interference and the instrument may not perform within the normal specification limits in such an environment. Criterion C was used for Electrostatic Discharge (ESD, IEC 61000-4-2) and Electric Fast Transit (EFT, Burst, IEC 61000-4-4). If the instrument is subjected to EFT conditions at 2kV, the instrument may require the user to cycle the power to return to normal operation.

11.2.1.2 Emission Testing

The instrument fulfills the limit requirements for Class A equipment but does not fulfill the limit requirements for Class B equipment. The instrument was not designed to be used in domestic establishments.

11.2.2 Low Voltage Directive (Safety)

In order to comply with the European Low Voltage Directive (73/23/EEC), Hart Scientific equipment has been designed to meet the IEC 1010-1 (EN 61010-1) and the IEC 1010-2-010 (EN 61010-2-010) standards.