

An Investigation into the Stability of Industrial Platinum Resistance Thermometers

Speaker: Xumo Li

Hart Scientific, 799 East Utah Valley Drive, American Fork, UT 84003
Phone: (801) 763 1600, Fax: (801) 763 1010, E-mail: xumo_li@hartscientific.com

Paper Authors: Xumo Li, Deming Chen, and Mingjian Zhao
Hart Scientific

Abstract

The stabilities of more than 20 industrial platinum resistance thermometer (IPRT) elements from four manufactures were investigated. All elements were assembled into probes with a sheath, and the assembly technique was found to be important to stability and accuracy. A set of apparatus was set up for the investigation. The test results with different sheathing materials and assembly techniques are compared. Drift rates as low as 0.002°C per 100 hours at 650°C were achieved. Two vital characteristics, thermal hysteresis and dielectric effect, were tested and are discussed in detail. Further improvements to the stability and accuracy of assembled IPRTs are discussed.

Introduction

Industrial platinum resistance thermometers (IPRTs) are widely used in many industries. A few investigations have shown the stability and accuracy of some types of IPRTs to be much better than the tolerances required by ASTM standards [1] for IPRTs. Hashemian found typical individually calibrated IPRTs could provide an initial accuracy of about $\pm 0.05^\circ\text{C}$ up to 300°C and maintain their accuracy to within $\pm 0.2^\circ\text{C}$ for two or more years [2].

Many applications require accuracy better than the tolerances in ASTM standards. This is illustrated by the control sensor of a fixed-point furnace, which requires an accuracy of 0.1°C or better up to 670°C. The tolerance given in ASTM E1137 for a grade A IPRT at 650°C is 1.24°C. In order to solve the problem concerning the accuracy of the fixed-point furnace control sensor, we started an investigation into the stability of IPRTs two years ago. We realized that the investigation might have much broader applications and appeal, especially for those interested in precise temperature measurements at low cost or in adverse conditions. Our research attempted to answer the following questions:

- What is the best accuracy we can obtain from modern high-quality IPRT sensors?
- What factors might influence the stability and accuracy of an IPRT?

- What is the maximum temperature limit for these IPRTs, given a required stability and accuracy?
- How can we improve stability and accuracy by selecting proper materials and assembly techniques?

The investigation is still in process. In this paper we report some preliminary results in the range up to 660°C.

IPRT Elements and Assembling

More than 20 elements from four manufactures were investigated. Some of them are listed in Table 1, below, with the names of their manufactures, model numbers, sizes, and assembly features.

Table 1 IPRTs Tested

Assigned S/N	Mfr	Model No	Diam. (mm)	Length (mm)	Sheath	Notes
M-1	A	S277	2.8	25	Alumina	
M-2	A	S277	2.8	25	Alumina	
M-3	A	S277	2.8	25	Inconel	
M-4	A	S277	2.8	25	Quartz	
W8-1	B	W86/2	3.0	32	Inconel	alumina capsule
W8-2	B	W86/2	3.0	32	Inconel	alumina capsule
W6-1	B	W60/4	2.8	30	Inconel	alumina capsule
K-1	C	K2515	1.6	25	Inconel	alumina capsule
K-2	C	K2515	1.6	25	Inconel	alumina capsule
K-3	C	K2515	1.6	25	Inconel	alumina capsule
T-1	D	P100/3038	3.8	30	Quartz	
T-2	D	P100/3038	3.8	30	Quartz	

A: MINCO Products, Inc., U.S.

B: Sensycon, Hartmann & Braun, Germany

C: Heraeus, Germany

D: Thermal Developments International Ltd., UK

All of the IPRT elements were attached to four 0.3-mm platinum wires insulated with a four-hole, quartz glass capillary. The four-lead construction of the assembly allows the true resistance to be measured without lead error. Platinum wires were used in order to reduce EMF error. The four-wire platinum element was enclosed into a sheath. Epoxy was used to seal the sheath from moisture. A copper cable with four leads was soldered to the platinum leads. Three kinds of materials were tested for the sheath: alumina, quartz, and Inconel. Quartz and alumina sheaths are easily broken, while Inconel is much stronger. Inconel is an attractive material for many applications. But as we will discuss later, the Inconel sheath was found to contaminate the sensor (element) at high temperatures, so some of the elements were enclosed in alumina capsules before being placed in the Inconel sheaths (Fig.1).

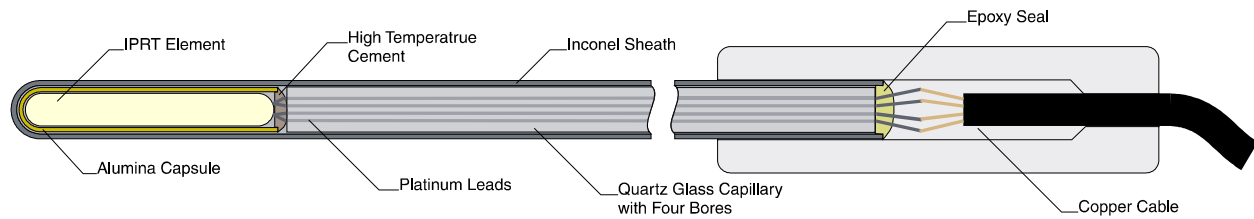

Fig. 1. An assembled IPRT with an alumina capsule

Apparatus

A set of apparatus was set up for the investigation of the IPRT. The set included an electrical measurement instrument, triple point of water (TPW, 0.01°C) cells, a melting point of gallium (MP Ga, 29.7646°C) cell, a freezing point of aluminum (FP Al, 660.323°C) cell, a dry-well calibrator (for comparison calibration in the range from 35°C to 660°C), and a reference standard platinum resistance thermometer (SPRT).

The Model 1590 Super-Thermometer was chosen for the electrical measurement instrument because it is easy to use, measures quickly, displays measurements graphically, and measures resistance ratios with high accuracy (1 ppm). A simplified schematic of the 1590 is shown in Fig. 2. The reference resistor and IPRT were connected in series. The voltage across the IPRT was compared through the relay switch with that across the reference resistor. The current was reversed automatically with an adjustable two-cycle measurement time from 2 to 10 seconds so that EMF errors could be minimized. Each measurement required four voltage samples, which was completed automatically in two seconds. An external 100-ohm standard resistor, maintained in a bath at 25°C , was used as the reference resistance.

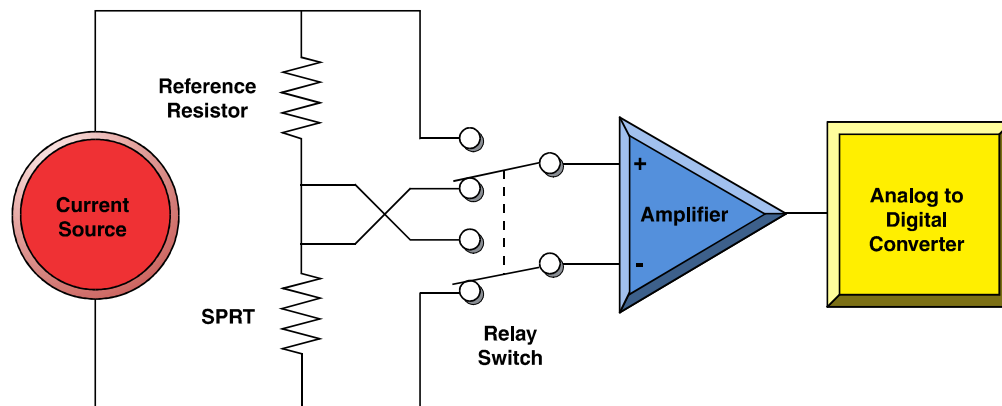

Fig. 2. Model 1590 simplified schematic

Three triple point of water cells were maintained in a bath at about 0.007°C . The stabilities of the IPRTs were checked mainly at the TPW. In order to check the stability of the resistance-temperature relationship through the whole temperature range, we later added the melting point of gallium (MP Ga) and the freezing point of aluminum (FP Al). The MP Ga cell was maintained in a bath at about 0.05°C above the gallium melting point. The melting plateau typically lasted for a few weeks, so the MP Ga could be used in a way similar to the TPW and ice point. The

expanded uncertainty ($k=2$) of the MP Ga was better than 0.2 mK. The FP Al was realized using a small cell and a portable furnace (Fig. 3). The furnace was much shorter than traditional furnaces and could easily be used on a table or bench. The furnace had a total height of 489 mm and outer diameter of 209 mm and it weighed only about 17 kg. Three heaters were used to obtain uniform temperatures around the small cell. The main heater covered the furnace's entire length, while the top and bottom zone heaters covered only the upper and lower parts of the furnace, respectively. Software within the unit's controller was used to adjust the ratios of the three heaters. Using this technique, we could achieve temperature uniformity within the cell of $\pm 0.1^\circ\text{C}$. We found that the melting technique is much easier and more convenient than the freezing technique for the IPRT test [3-6]. We set the furnace to about 0.5°C above the freezing point and the melting plateau usually lasted more than ten hours. Ten or more IPRTs could be measured on a single melting curve. We usually started a melting curve in the morning and were able to use it for most of the day. Later in the afternoon, we set the furnace temperature to freeze the aluminum and the next day we started another melting curve. The expanded uncertainty ($k=2$) of the FP Al, using the melting technique, is 5 mK.

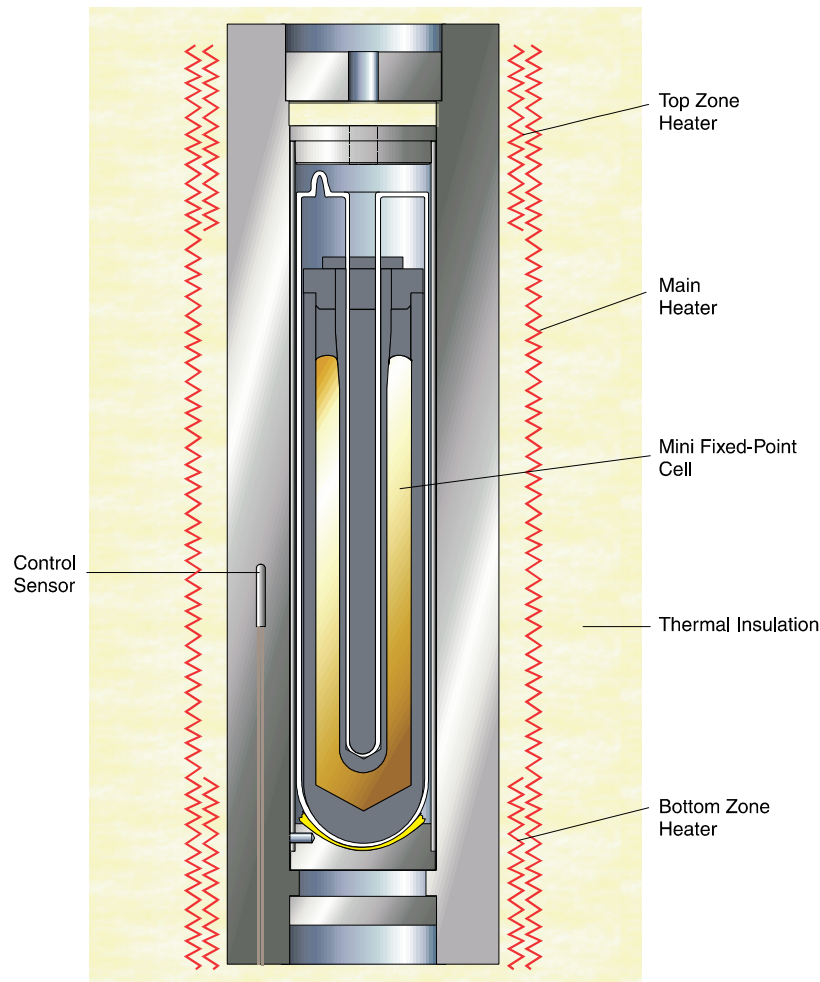

Fig. 3. A small aluminum cell in a portable furnace

A Model 9122 Dry-Well was used for comparison calibration in the range from 35°C to 650°C. Up to eight IPRTs could be compared with a reference SPRT in the dry-well. The well depth was 152 mm (6 inches). The typical stability at 650°C was $\pm 0.03^\circ\text{C}$ over an hour and the uniformity from well to well was within $\pm 0.1^\circ\text{C}$. The dry-well was used for annealing as well.

Stability of IPRTs Heated to About 660°C for Extended Periods

Two elements each of the same model from the same manufacturer were assembled into two IPRTs with different materials for each sheath: M-1 used an alumina sheath and M-3 used an Inconel sheath. Both were heated to about 660°C for a period of time, and then their resistance at the TPW was measured. The process was repeated many times; Fig. 4 shows the results. It is clear that the change for M-3 was much larger than that for M-1. We believe the M-3 platinum element was contaminated by the Inconel sheath at 660°C. The M-3 IPRT was further annealed at 660°C for more than 5,000 hours and its R_{tp} continued to rise. Fig. 5 shows the changes in R_{tp} during the entire annealing process.

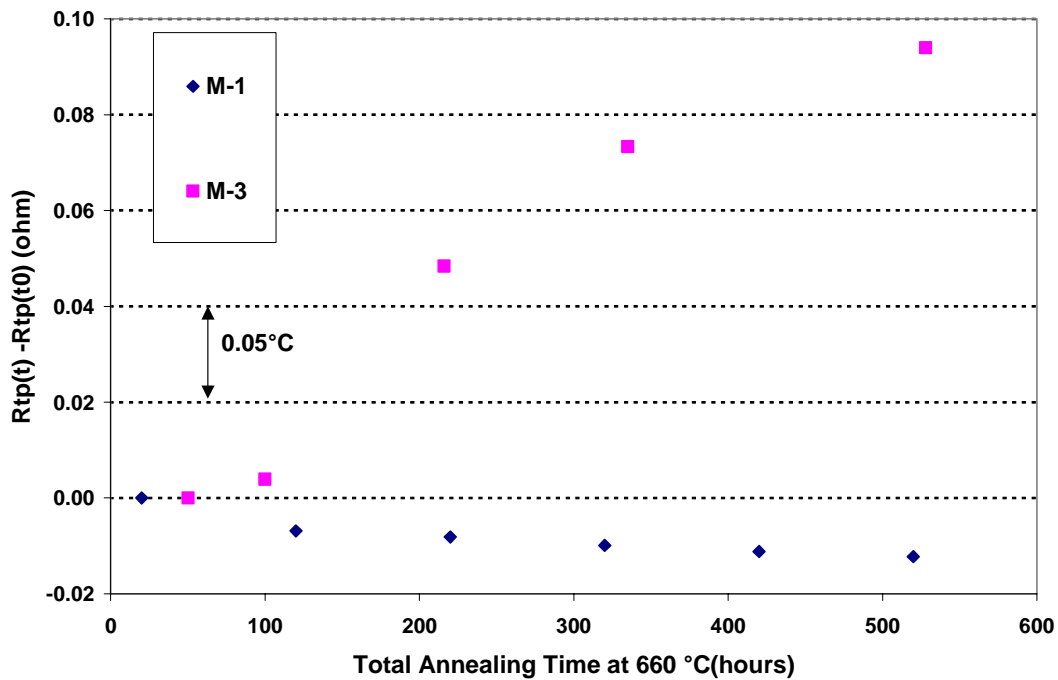

Fig.4. Changes in R_{tp} of two IPRTs with different sheaths when heated to 660°C

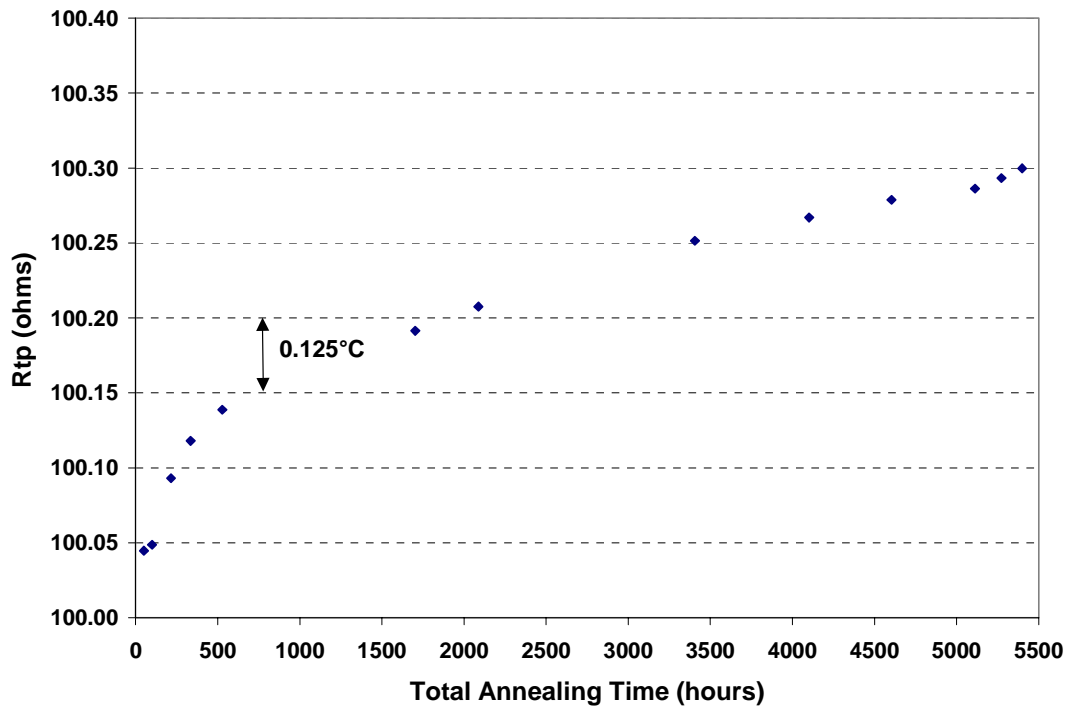

Fig. 5. Rtp of M-3 IPRT during annealing at 660°C for over 5,000 hours

We tried several ways to protect the platinum elements from Inconel contamination. Eventually we found that an alumina capsule can indeed protect the element from contamination. Six elements from two manufacturers were enclosed in alumina capsules and then sealed into Inconel sheaths (see Table 1). They were tested in a similar way as M-1 and M-3. The six IPRTs were annealed at about 650°C for more than 4,000 hours. Fig. 6 and Fig. 7 show the results for two of them (W8-1 and K-2). Fig. 8 compares the stability of an IPRT with an alumina capsule (K-3) with that of an IPRT without an alumina capsule (M-3). Obviously, the alumina capsule decreased the drift rate and improved the stability greatly. After heating at about 650°C for 3,000 hours, the change in Rtp decreased from the equivalent of 0.5°C for M-3 (without the alumina capsule) to 0.05°C for K-3 (with the alumina capsule).

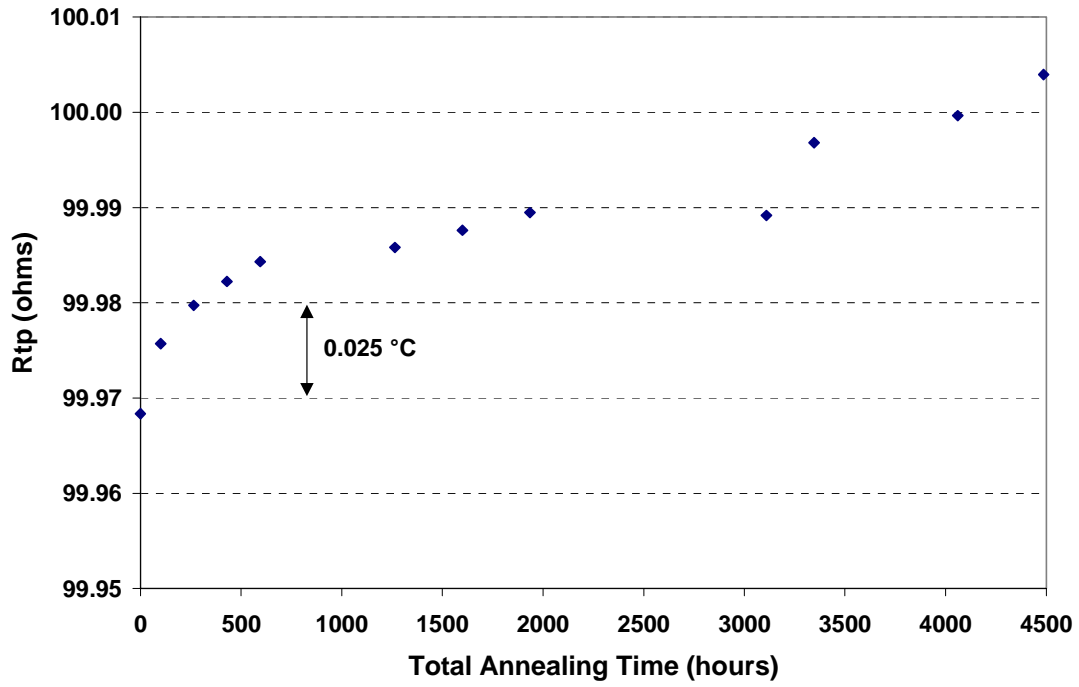

Fig.6. Rtp of W8-1 during annealing at 650°C for over 4,000 hours

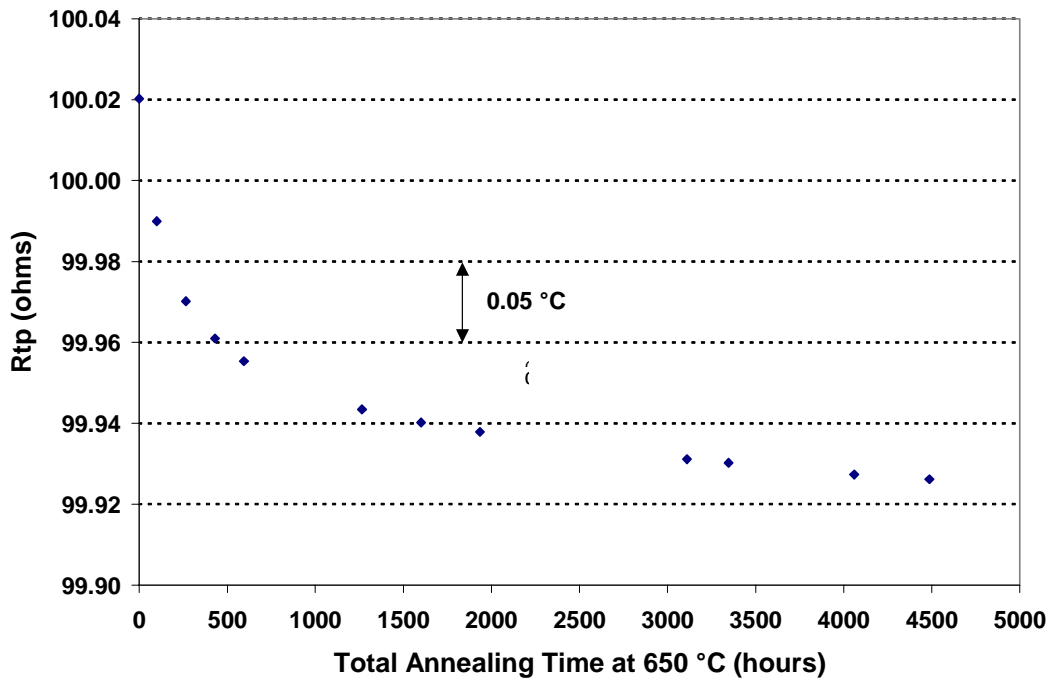

Fig. 7. Rtp of K-2 during annealing at 650°C for over 4,000 hours

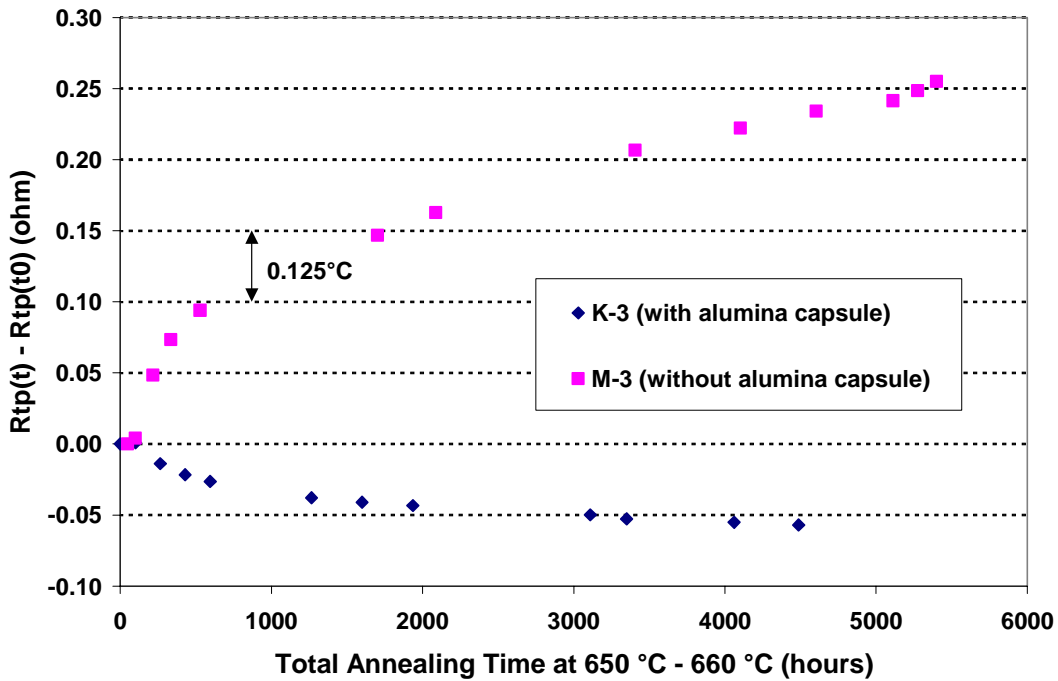

Fig.8. Comparison of stability of IPRTs with and without alumina capsules

In order to check the drift of the IPRTs over their entire range, the IPRTs were not only measured at the TPW, but also at the FP Al and MP Ga after heating to 650°C for a certain period of time. Fig. 9, Fig. 10, Fig. 11, and Fig.12 show some of the results. The resistance at the FP Al [R(Al)] for K-1 seemed to be extremely stable during the entire 2,000 hours at 650°C; the maximum change in R(Al) was equivalent to 0.0016°C. The change in R(Al) for K-2 was within 0.01°C for the same process. The change in R(Al) for W8-1 was a little larger, but it was still within 0.2°C. If we use the resistance ratio $W(Al) = R(Al)/R_{tp}$ as we usually do with SPRTs (instead of the absolute resistance R(Al)), the change would decrease to within 0.05°C (Fig. 12). The changes at the MP Ga of IPRTs were similar to the FP Al, though they were smaller.

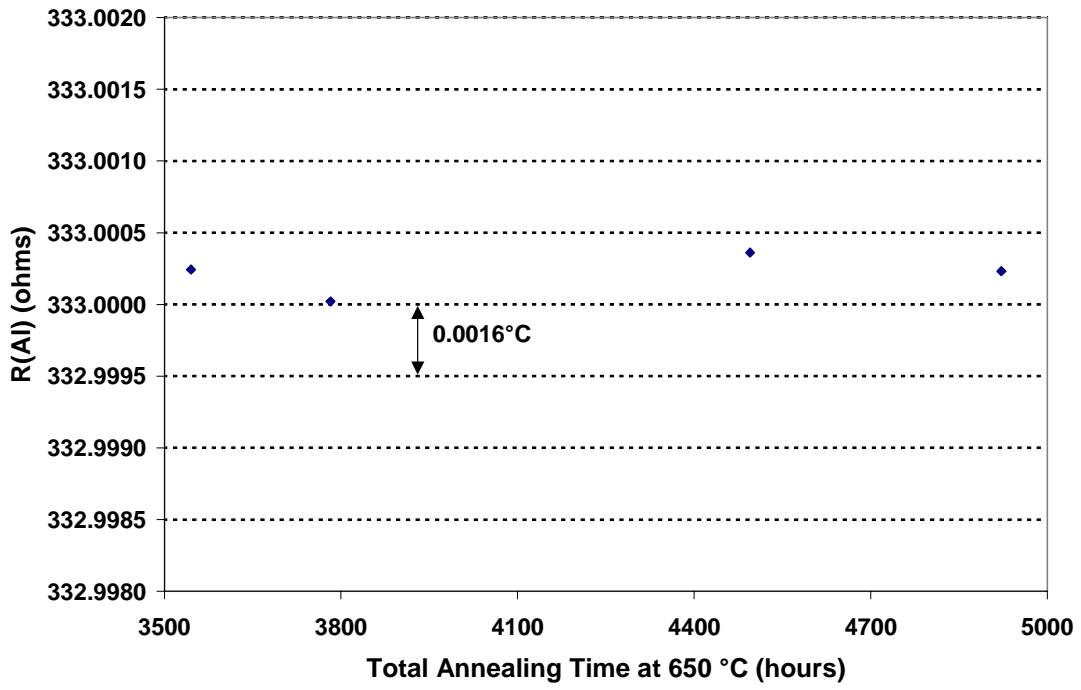

Fig. 9. The resistance $R(\text{Al})$ of K-1 during annealing at 650°C

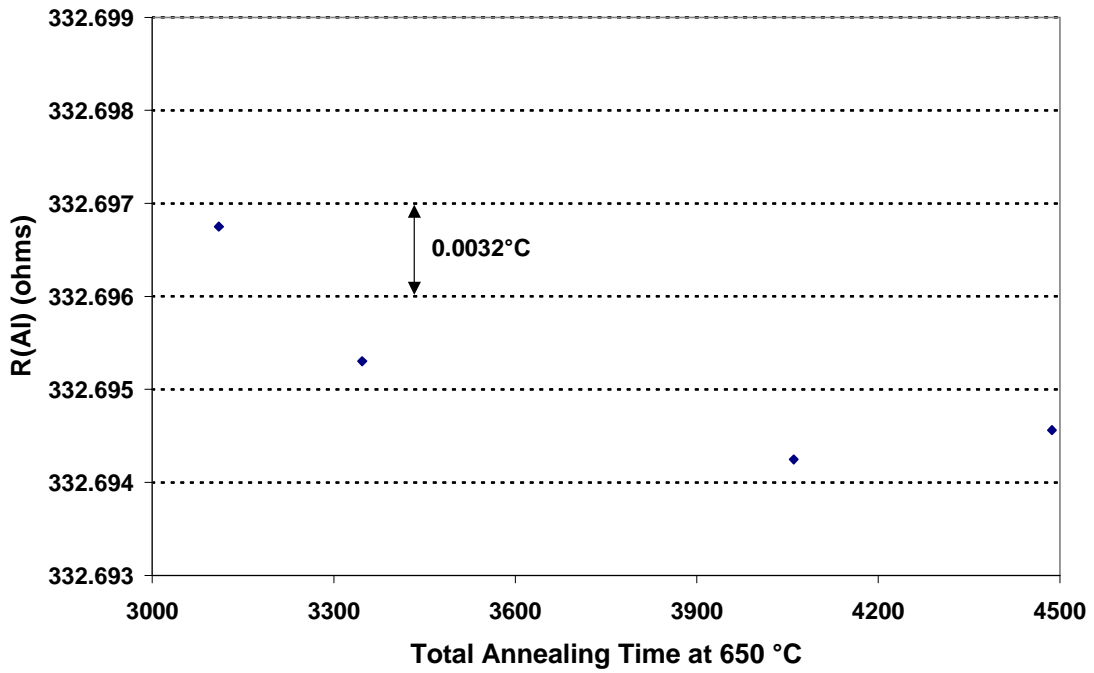

Fig. 10. The resistance $R(\text{Al})$ of K-2 during annealing at 650°C

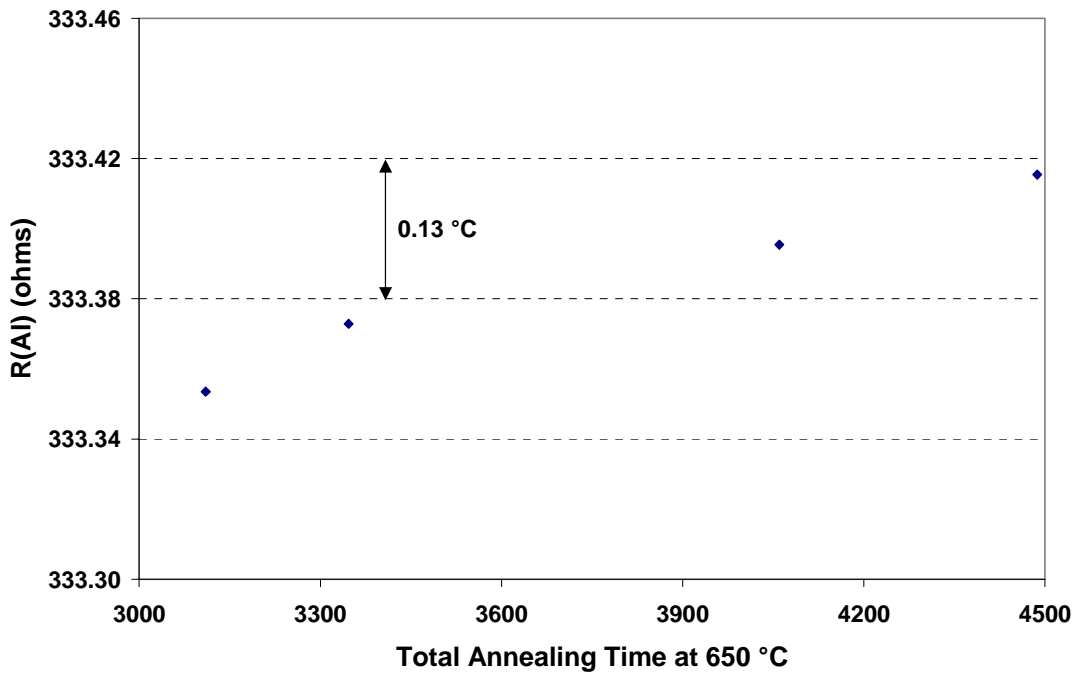

Fig. 11. The resistance $R(Al)$ of W8-1 during annealing at 650°C

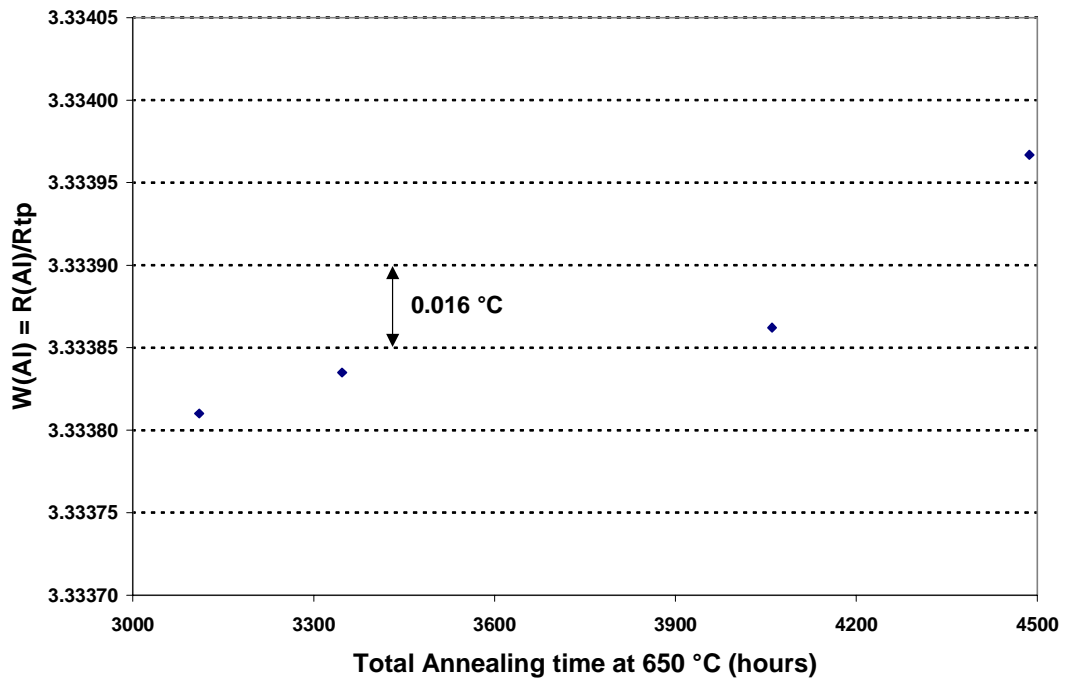

Fig. 12. The resistance ratio $W(Al)$ of W8-1 during annealing at 650°C

Effect of Current Reversal Period (Dielectric Effect)

It was found that there is another important effect that can influence the stability and accuracy of an IPRT above about 200°C. When we changed the measurement time or frequency of the measuring circuit only, a change in display temperature as large as 0.3°C was detected in the laboratory with some models of IPRTs. Even if DC is used to measure the resistance, the current's direction must be reversed periodically in order to eliminate EMF errors. Most modern measuring instruments using an IPRT element as a sensor use either DC circuits with automatic reversal of current or an AC circuit. So, this phenomenon is present in most IPRT applications.

In order to investigate the effect of the current reversal period in detail, seven IPRTs from three manufactures were calibrated at the TPW, MP Ga and FP Al using three different measurement times (2s, 5s, and 10s). An SPRT was calibrated at the three fixed points at the same time for comparison purposes. No distinct differences were detected with various measurement times at the TPW and MP Ga; all were within the repeatability of the measurement system, which is approximately 0.3 mK. The results obtained at the FP Al are shown in Fig. 13 and Fig. 14. Fig. 14 is actually the same data as Fig. 13, the only difference being that a logarithmic scale is used for the y-axis so very small changes with different measurement times can be seen clearly. There is almost no such effect detected for the SPRT. The effects with the IPRTs from the same manufacturer are very similar. Some models of IPRTs exhibited very small effects: within 0.002°C for the model W86/2 and within 0.005°C for the model W60/24. The differences for K2515 are in the range of 0.005°C to 0.03°C. S277 showed the largest change, up to 0.3°C. Further investigation indicates this effect is mainly related to the sealing material used in the IPRT elements. Dielectric absorption of the sealing material, especially at high temperatures, is the primary mechanism. Micro-dipoles exist in the molecules of some materials. When the direction of the outside electric field changes, the orientation of the dipoles in the molecules of many insulator materials also changes. This explains why elements of the same model have very similar effects, because they use the same sealing material. On the other hand, elements of different models exhibit different magnitudes of this effect because they use different sealing materials. There are large differences in dielectric absorption among different insulator materials. Consequently, manufactures of IPRT elements should pay attention to dielectric characteristics when they chose sealing materials.

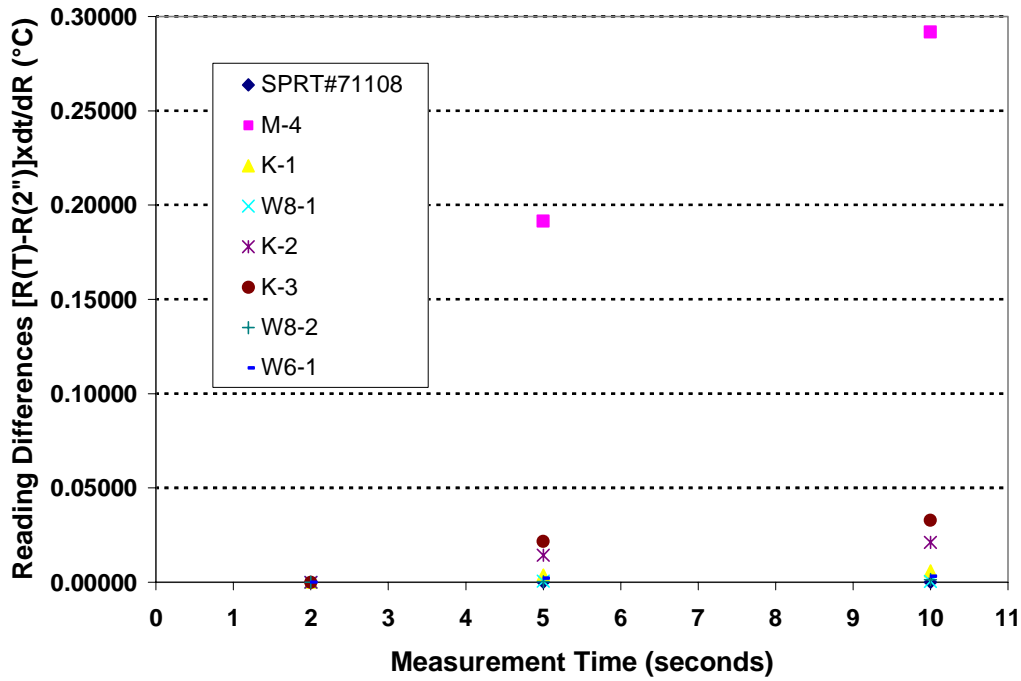

Fig. 13. Effects of measurement time on measurement results of different IPRTs

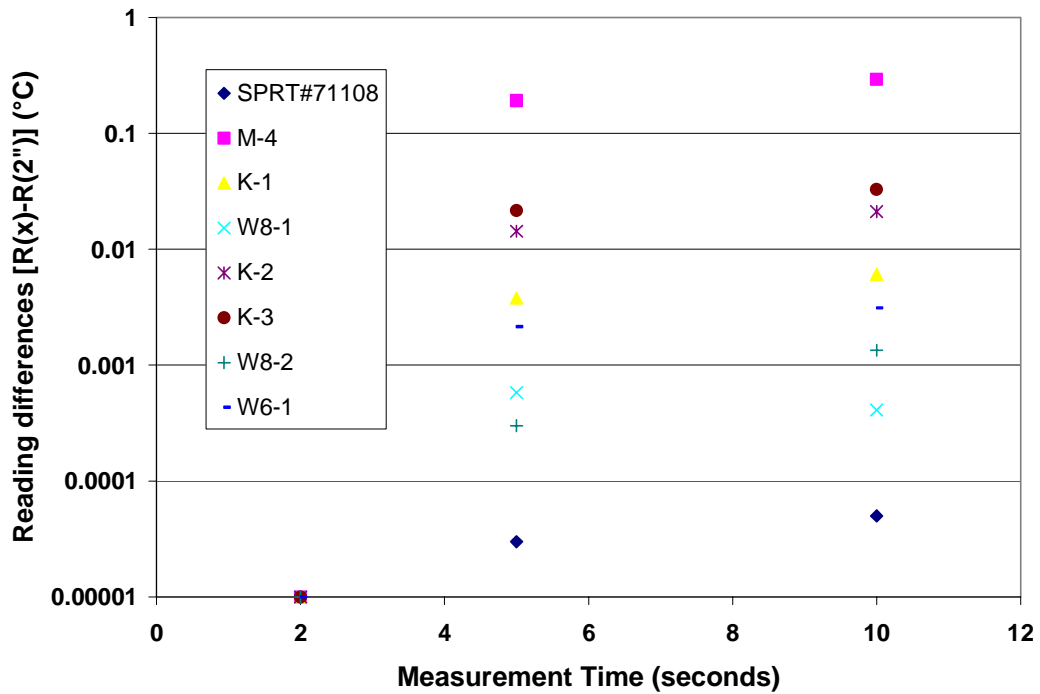

Fig. 14. Effects of measurement time on measurement results of different IPRTs (logarithmic scale)

Thermal Hysteresis Effect

Another important effect, which limits the accuracy and stability of an IPRT, is thermal hysteresis. Curtis pointed out that an IPRT may have a different but reproducible R vs. T relationship depending on the thermal history of the element and whether it is being heated or cooled [7]. It has been almost twenty years since Curtis published his paper on thermal hysteresis. Perhaps improvements have been made in the manufacturing of IPRT elements since then. We decided to investigate the thermal hysteresis of modern IPRT elements.

Three IPRTs from two manufacturers were calibrated against an SPRT in a dry-well. The calibration sequence was as follows: it started at 50°C, then went to 350°C, then 650°C, then down to 350°C, and finally back to 50°C. It took two days to complete the calibrations. During the process, we kept the SPRT and the IPRTs in the same blocks in order to decrease the influence of temperature gradients in the dry-well on the calibration results. The temperature stability of the dry-well was about $\pm 0.02^\circ\text{C}$. In order to decrease the influence of heat source instability on the calibration results, two Model 1590s were used in the calibration. One was used to measure the resistance of the SPRT and another to simultaneously measure the IPRT. The repeatability of the calibration was approximately 0.003°C . Fig 15 shows the results for IPRT W8-2. The difference between heating and cooling at 350°C was about $\pm 0.04^\circ\text{C}$, or less than 0.01 % of the operating temperature range. Fig. 16 shows the results for K-3. The difference between heating and cooling at 350°C was about $\pm 0.005^\circ\text{C}$, or less than 0.001 % of the operating temperature range. The amounts of thermal hysteresis were much smaller than what Curtis reported (up to 0.1%). Improvements of the IPRT element manufacturing techniques may be the reason for the lower thermal hysteresis.

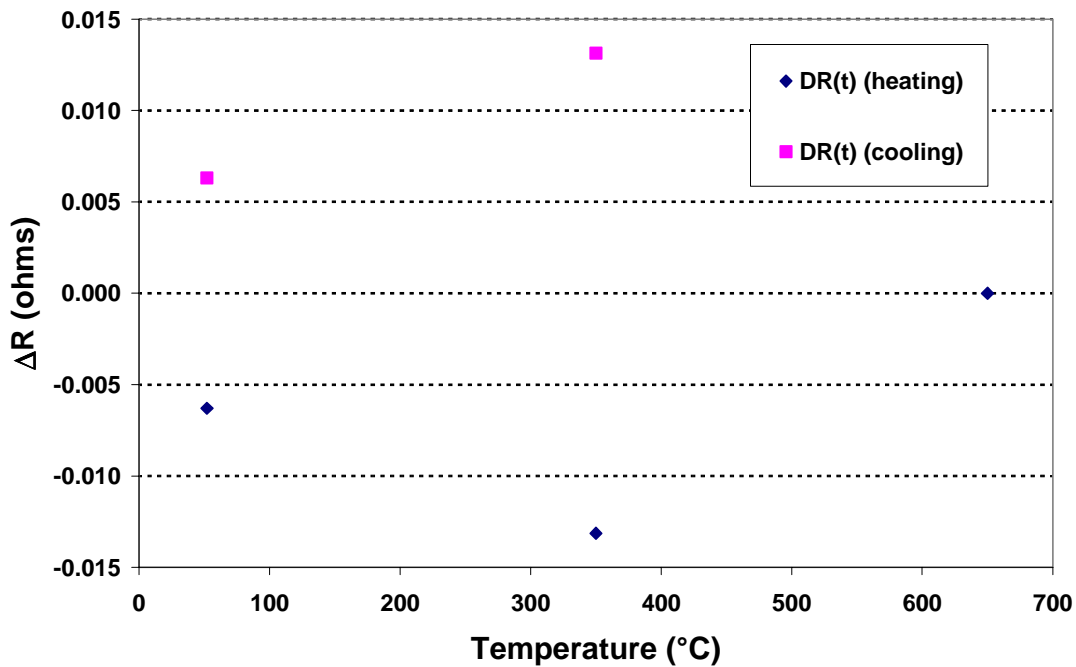

Fig. 15. Difference of calibration results of W8-2 between heating and cooling

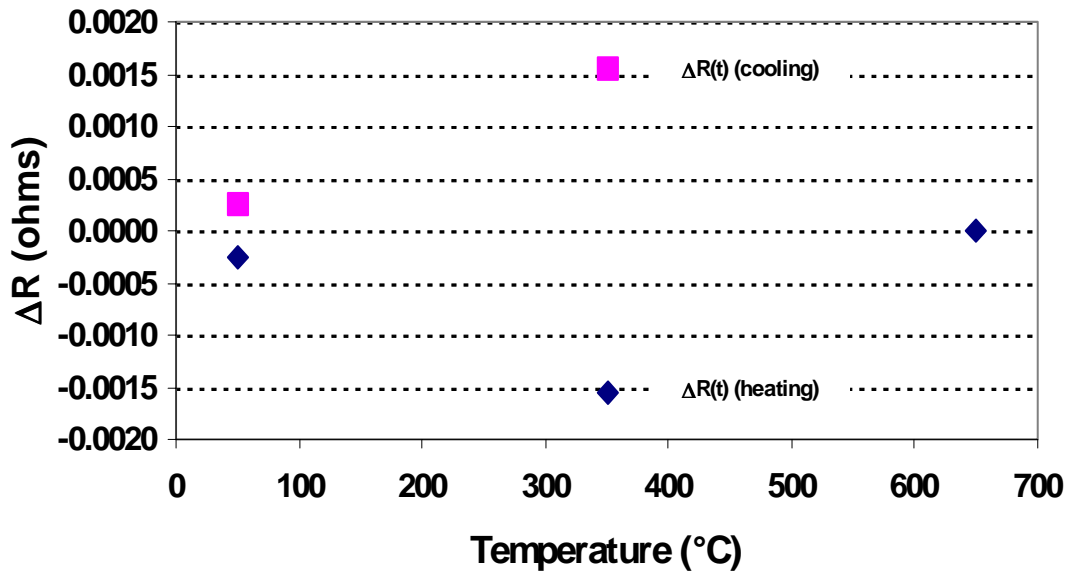

Fig. 16. Difference of calibration results of K-3 between heating and cooling

Conclusion and Discussion

Carefully assembled IPRT probes can achieve much better stability and accuracy than commonly believed or what ASTM or IEC specify for IPRTs of Grade A. It is important to avoid contamination of the platinum from the sheath material and to minimize the EMF and lead resistance errors in order to obtain high stability and accuracy.

Drift rates as low as 0.002°C per 100 hours at about 650°C can be obtained. With a carefully selected high-quality element, it is possible to obtain an accuracy of 0.02°C or better in the range to 660°C. These specially assembled IPRT probes are rugged, low-cost thermometers with moderate accuracy. These probes will find broad applications in many industries and laboratory work where moderate accuracy can satisfy application requirements.

Thermal hysteresis and dielectric effects in sealing materials are two vital characteristics affecting the quality of the element. The best elements we purchased showed a thermal hysteresis below 0.01°C in the range from 0°C to 660°C. Some other elements show a little larger thermal hysteresis ($\pm 0.04^\circ\text{C}$). Manufacturers of elements can improve thermal hysteresis of their elements by proper design of the element. We found a large range of errors from the dielectric effect (from 0.002°C to 0.3°C) among the IPRT elements we tested. Element manufacturers can improve their accuracy by selecting proper sealing materials.

Acknowledgments

The authors express heartfelt thanks to Mike Hirst and Rick Walker for meaningful advice and useful discussions and to Wayne Newland for helping to draw figures and format the paper.

References

1. ASTM E 1137-97, "Standard Specification for Industrial Platinum Resistance Thermometers"
2. Hashemian, H. M. and Petersen, K. M., "Achievable Accuracy and Stability of Industrial RTDs," TMCSI, Vol. 6, p.427 (1992)
3. Li, X. et al. "The Melting Point of Tin," National Conference of Standards Laboratories (NCSL) Symposium, Vol. 1, 1996, p. 419
4. Li, X. and Hirst, M., "The Comparison Between the Freezing Point and Melting Point of Tin," The 6th International Symposium on Temperature and Thermal Measurements in Industry and Science (TEMPMEKO '96), p. 63, Torino, Italy, September 10-12, 1996
5. Li, X. and Hirst, M., "New Generation of Fixed Points," National Conference of Standards Laboratories (NCSL) Symposium, Vol. 2, p. 567 (1997)
6. Li, X. and Hirst, M., "Fixed Points for Secondary Level Calibrations," The 7th International Symposium on Temperature and Thermal Measurements in Industry and Science (TEMPMEKO '99), Vol. 1, p. 74, Delft, the Netherlands, June 1-3, 1999
7. Curtis, D. J., "Thermal Hysteresis and Stress Effects in Platinum Resistance Thermometers," TMCSI, Vol. 5, p.803 (1982)