

# 7341

Calibration Bath

## Users Guide

## LIMITED WARRANTY AND LIMITATION OF LIABILITY

Each Fluke product is warranted to be free from defects in material and workmanship under normal use and service. The warranty period is one year and begins on the date of shipment. Parts, product repairs, and services are warranted for 90 days. This warranty extends only to the original buyer or end-user customer of a Fluke authorized reseller, and does not apply to fuses, disposable batteries, or to any product which, in Fluke's opinion, has been misused, altered, neglected, contaminated, or damaged by accident or abnormal conditions of operation or handling. Fluke warrants that software will operate substantially in accordance with its functional specifications for 90 days and that it has been properly recorded on non-defective media. Fluke does not warrant that software will be error free or operate without interruption.

Fluke authorized resellers shall extend this warranty on new and unused products to end-user customers only but have no authority to extend a greater or different warranty on behalf of Fluke. Warranty support is available only if product is purchased through a Fluke authorized sales outlet or Buyer has paid the applicable international price. Fluke reserves the right to invoice Buyer for importation costs of repair/replacement parts when product purchased in one country is submitted for repair in another country.

Fluke's warranty obligation is limited, at Fluke's option, to refund of the purchase price, free of charge repair, or replacement of a defective product which is returned to a Fluke authorized service center within the warranty period.

To obtain warranty service, contact your nearest Fluke authorized service center to obtain return authorization information, then send the product to that service center, with a description of the difficulty, postage and insurance prepaid (FOB Destination). Fluke assumes no risk for damage in transit. Following warranty repair, the product will be returned to Buyer, transportation prepaid (FOB Destination). If Fluke determines that failure was caused by neglect, misuse, contamination, alteration, accident, or abnormal condition of operation or handling, including overvoltage failures caused by use outside the product's specified rating, or normal wear and tear of mechanical components, Fluke will provide an estimate of repair costs and obtain authorization before commencing the work. Following repair, the product will be returned to the Buyer transportation prepaid and the Buyer will be billed for the repair and return transportation charges (FOB Shipping Point).

THIS WARRANTY IS BUYER'S SOLE AND EXCLUSIVE REMEDY AND IS IN LIEU OF ALL OTHER WARRANTIES, EXPRESS OR IMPLIED, INCLUDING BUT NOT LIMITED TO ANY IMPLIED WARRANTY OF MERCHANTABILITY OR FITNESS FOR A PARTICULAR PURPOSE. FLUKE SHALL NOT BE LIABLE FOR ANY SPECIAL, INDIRECT, INCIDENTAL, OR CONSEQUENTIAL DAMAGES OR LOSSES, INCLUDING LOSS OF DATA, ARISING FROM ANY CAUSE OR THEORY.

Since some countries or states do not allow limitation of the term of an implied warranty, or exclusion or limitation of incidental or consequential damages, the limitations and exclusions of this warranty may not apply to every buyer. If any provision of this Warranty is held invalid or unenforceable by a court or other decision-maker of competent jurisdiction, such holding will not affect the validity or enforceability of any other provision.

Fluke Corporation  
P.O. Box 9090  
Everett, WA 98206-9090  
U.S.A.

Fluke Europe B.V.  
P.O. Box 1186  
5602 BD Eindhoven  
The Netherlands

11/99

To register your product online, visit [register.fluke.com](http://register.fluke.com)

# Table of Contents

Chapter	Title	Page
<b>1</b>	<b>Before You Start</b> .....	<b>1-1</b>
	Symbols Used .....	1-3
	Safety Information .....	1-4
	Authorized Service Centers .....	1-7
<b>2</b>	<b>Introduction</b> .....	<b>2-1</b>
<b>3</b>	<b>Specifications and Environmental Conditions</b> .....	<b>3-1</b>
	Specifications .....	3-3
	Environmental Conditions .....	3-4
<b>4</b>	<b>Quick Start</b> .....	<b>4-1</b>
	Unpacking .....	4-3
	Set Up .....	4-3
	Power .....	4-5
	Setting the Temperature .....	4-5
<b>5</b>	<b>Installation</b> .....	<b>5-1</b>
	Moving or Uncrating the Bath .....	5-3
	Bath Environment .....	5-3
	Tipping Prevention Bracket Installation .....	5-3
	Installation On A Wood Floor .....	5-3
	Installation On a Concrete Floor .....	5-4
	Installation Of The Bath .....	5-4
	“Dry-out” Period .....	5-4
	Bath Preparation and Filling .....	5-5
	Power .....	5-5
<b>6</b>	<b>Bath Use</b> .....	<b>6-1</b>
	General .....	6-3
	Comparison Calibration .....	6-3
	Calibration of Multiple Probes .....	6-4

<b>7</b>	<b>Parts and Controls .....</b>	<b>7-1</b>
	Front Control Panel.....	7-3
	Back Panel .....	7-3
	Fluid Expansion Reservoir.....	7-3
<b>8</b>	<b>General Operation .....</b>	<b>8-1</b>
	Heat Transfer Fluid.....	8-3
	Temperature Range .....	8-3
	Viscosity.....	8-3
	Specific Heat .....	8-3
	Thermal Conductivity.....	8-3
	Thermal Expansion.....	8-3
	Electrical Resistivity.....	8-4
	Fluid Lifetime .....	8-4
	Safety.....	8-4
	Cost.....	8-5
	Commonly Used Fluids.....	8-5
	Water.....	8-5
	Ethylene Glycol.....	8-5
	Mineral Oil .....	8-5
	Silicone Oil .....	8-6
	Fluid Characteristics Charts.....	8-6
	Limitations and Disclaimer .....	8-6
	About the Chart.....	8-8
	Stirring.....	8-10
	Power.....	8-10
	Heater.....	8-10
	Temperature Controller.....	8-10
	Refrigeration.....	8-11
<b>9</b>	<b>Controller Operation .....</b>	<b>9-1</b>
	Bath Temperature .....	9-3
	Reset Cutout.....	9-3
	Temperature Set-point .....	9-5
	Programmable Set-points .....	9-5
	Set-point Value.....	9-5
	Set-point Vernier .....	9-6
	Scan.....	9-6
	Scan Control .....	9-6
	IScan Rate.....	9-6
	Temperature Scale Units.....	9-7
	Ramp and Soak Program .....	9-7
	Number of Program Set-points.....	9-7
	Set-points.....	9-8
	Program Soak Time.....	9-8
	Program Function Mode.....	9-8
	Program Control.....	9-9
	Secondary Menu .....	9-9
	Heater Power.....	9-9
	Proportional Band .....	9-10
	Cutout .....	9-12
	Controller Configuration.....	9-13
	Probe Parameters .....	9-13
	R0 .....	9-13

	ALPHA.....	9-13
	Operating Parameters.....	9-13
	Cutout Reset Mode.....	9-13
	Cooling Mode.....	9-14
	Hot Gas Bypass Mode.....	9-14
	Serial Interface Parameters.....	9-15
	Baud Rate.....	9-15
	Sample Period.....	9-15
	Duplex Mode.....	9-15
	Linefeed.....	9-16
	IEEE-488 Parameters.....	9-16
	IEEE-488 Address.....	9-16
	Transmission Termination.....	9-17
	Calibration Parameters.....	9-17
	CTO.....	9-17
	CO and CG.....	9-17
	H and L.....	9-17
	HGbt.....	9-17
<b>10</b>	<b>Digital Communication Interface .....</b>	<b>10-1</b>
	Serial Communications.....	10-3
	Wiring.....	10-3
	Setup.....	10-3
	Baud Rate.....	10-4
	Sample Period.....	10-4
	Duplex Mode.....	10-4
	Linefeed.....	10-4
	Serial Operation.....	10-4
	IEEE-488 Communication (optional).....	10-4
	Setup.....	10-5
	IEEE-488 Address.....	10-5
	Transmission Termination.....	10-5
	IEEE-488 Operation.....	10-5
	Interface Commands.....	10-5
	Cooling Control.....	10-5
<b>11</b>	<b>Calibration Procedure .....</b>	<b>11-1</b>
	Calibration Points.....	11-3
	Measuring the Set-point Error.....	11-3
	Computing R0 and ALPHA.....	11-3
	Calibration Example.....	11-4
<b>12</b>	<b>Maintenance.....</b>	<b>12-1</b>
<b>13</b>	<b>Troubleshooting .....</b>	<b>13-1</b>
	Troubleshooting.....	13-3
	Comments.....	13-6
	EMC Directive.....	13-6
	Immunity Testing.....	13-6
	Emission Testing.....	13-6
	Low Voltage Directive (Safety).....	13-6



# ***List of Tables***

<b>Table</b>	<b>Title</b>	<b>Page</b>
1-1.	International Electrical Symbols .....	1-3
3-1.	Specifications .....	3-3
8-1.	Various Bath Fluids and Their Properties .....	8-7
9-1.	Program Mode Setting Actions .....	9-9
9-2.	Typical Proportional Band Settings for Various Fluids .....	9-11
10-1.	Interface Command Summary .....	10-6





# ***List of Figures***

<b>Figure</b>	<b>Title</b>	<b>Page</b>
4-1.	Stir Baffle Fill Levels .....	4-4
5-1.	Tipping Prevention Bracket Installation .....	5-4
7-1.	Front Control Panel .....	7-3
8-1.	Chart of Various Bath Fluids and Their Properties .....	8-9
9-1.	Controller Operation Flowchart .....	9-4
9-2.	Bath Temperature Fluctuation At Various Proportional Band Settings .....	9-10
10-1.	Serial Communications Cable Wiring.....	10-3
11-1.	Calibration Example.....	11-4



# **Chapter 1**

## ***Before You Start***











<b>Title</b>	<b>Page</b>
Symbols Used .....	1-3
Safety Information .....	1-4
Authorized Service Centers .....	1-7



## Symbols Used

Table 1 lists the International Electrical Symbols. Some or all of these symbols may be used on the instrument or in this manual.

**Table 1-1. International Electrical Symbols**

Symbol	Description
~	AC (Alternating Current)
≈	AC-DC
	Battery
CE	Complies with European Union directives
≡	DC
	Double Insulated
	Electric Shock
	Fuse
	PE Ground
	Hot Surface (Burn Hazard)
	Read the User's Manual (Important Information)
O	Off
I	On
	Canadian Standards Association
CAT II	OVERVOLTAGE (Installation) CATEGORY II, Pollution Degree 2 per IEC1010-1 refers to the level of Impulse Withstand Voltage protection provided. Equipment of OVERVOLTAGE CATEGORY II is energy-consuming equipment to be supplied from the fixed installation. Examples include household, office, and laboratory appliances.
	C-TIC Australian EMC mark
	The European Waste Electrical and Electronic Equipment (WEEE) Directive (2002/96/EC) mark.

## Safety Information

Use this instrument only as specified in this manual. Otherwise, the protection provided by the instrument may be impaired. Refer to the safety information in Warnings and Cautions sections.

The following definitions apply to the terms “Warning” and “Caution”.

- “WARNING” identifies conditions and actions that may pose hazards to the user.
- “CAUTION” identifies conditions and actions that may damage the instrument being used.

### Warning

**To avoid possible electrical shock or personal injury, follow these guidelines.**

#### **GENERAL:**

- **DO NOT use the instrument for any application other than calibration work. The instrument was designed for temperature calibration. Any other use of the instrument may cause unknown hazards to the user.**
- **DO NOT use the instrument in environments other than those listed in the user’s guide.**
- **DO NOT overfill the bath. Overflowing extremely cold or hot fluid may be harmful to the operator. See Bath Preparation and Filling in Chapter 5 for specific instructions.**
- **Follow all safety guidelines listed in the user’s manual.**
- **Calibration Equipment should only be used by Trained Personnel.**
- **If this equipment is used in a manner not specified by the manufacturer, the protection provided by the equipment may be impaired.**
- **Before initial use, or after transport, or after storage in humid or semi-humid environments, or anytime the instrument has not been energized for more than 10 days, the instrument needs to be energized for a “dry-out” period of 2 hours before it can be assumed to meet all of the safety requirements of the IEC 1010-1. If the product is wet or has been in a wet environment, take necessary measures to remove moisture prior to applying power such as storage in a low humidity temperature chamber operating at 50°C for 4 hours or more.**
- **DO NOT operate high temperature baths (500°C) near flammable materials. Extreme temperatures could ignite the flammable material.**
- **Overhead clearance is required. Do not place the instrument under a cabinet or other structure. Always leave enough clearance to allow for safe and easy insertion and removal of probes.**

- The instrument is intended for indoor use only.
- The bath is a precision instrument. Although it has been designed for optimum durability and trouble free operation, it must be handled with care. Position the bath before the tank is filled with fluid by rolling it into place. **DO NOT** attempt to lift the bath. Due to the weight of the compressor, it may require two people to safely move the bath. The area containing the compressor will be heavier than the rest of the bath. **DO NOT** move a bath filled with fluid (see Moving or Uncrating the Bath in Chapter 5).

**BURN HAZARD:**

- Extremely cold temperatures may be present in this equipment. Freezer burns and frostbite may result if personnel fail to observe safety precautions.
- High temperatures may be present in this equipment. Fires and severe burns may result if personnel fail to observe safety precautions.
- The drain tube and dust cover of the Fluid Expansion Reservoir may be hot. Handle them carefully and always be sure the drain tube is fully inserted into the elbow of the dust cover.
- The drain tube of the Fluid Expansion Reservoir is not designed to handle large flow rates encountered by overfilling the tank. It is intended for expanding fluid rates from heating only. Fill tank only until the level reaches the top of the baffle (see Figure 4-1).

**ELECTRICAL HAZARD:**

- These guidelines must be followed to ensure that the safety mechanisms in this instrument will operate properly. This instrument must be plugged into a 115 VAC, 60Hz (230 VAC, 50Hz optional), AC only electric outlet. The power cord of the instrument is equipped with a three-pronged grounding plug for your protection against electrical shock hazards. It must be plugged directly into a properly grounded three-prong receptacle. The receptacle must be installed in accordance with local codes and ordinances. Consult a qualified electrician. **DO NOT** use an extension cord or adapter plug.
- **DO** use a ground fault interrupt device. This instrument contains a fluid. A ground fault device is advised in case fluid is present in the electrical system and could cause an electrical shock.
- Always replace the power cord with an approved cord of the correct rating and type. If you have questions, contact an Authorized Service Center (see Authorized Service Centers in Chapter 1).
- High voltage is used in the operation of this equipment. Severe injury or death may result if personnel fail to observe the safety precautions. Before working inside the equipment, turn off the power and disconnect the power cord.

## BATH FLUIDS:

- Fluids used in this bath may produce noxious or toxic fumes under certain circumstances. Consult the fluid manufacturer's MSDS (Material Safety Data Sheet). Proper ventilation and safety precautions must be observed.
- The instrument is equipped with a soft cutout (user settable firmware) and a hard cutout (set at the factory). Check the flash point, boiling point, or other fluid characteristic applicable to the circumstances of the bath operation. Ensure that the soft cutout is adjusted to the fluid characteristics of the application. As a guideline, the soft cutout should be set 10°C to 15°C below the flash point of the bath fluid. See Transfer Fluid (Chapter 8), for specific information on bath fluids and Cutout (Chapter 9).

### Caution

- Always operate this instrument at room temperature between 41°F and 122°F (5°C to 50°C). Allow sufficient air circulation by leaving at least 6 inches (15 cm) of clearance around the instrument.
- When filling the tank, ensure the immersion coils are completely covered. DO NOT fill above the stir baffle (see Figure 4-1).
- DO NOT overfill the bath. Overflowing fluid may damage the electrical system. See Bath Preparation and Filling (Chapter 5) for specific instructions.
- Read Chapter 6, Bath Use, before placing the bath into service.
- DO NOT turn the bath on without fluid in the tank and the heating coils fully immersed. See Fluid Expansion Reservoir (Chapter 7) for more information on Fluid Expansion Reservoir use.
- No matter what fluid is used, DO NOT exceed the recommended fluid viscosity.
- DO NOT change the values of the bath calibration constants from the factory set values. The correct setting of these parameters is important to the safety and proper operation of the bath.
- The refrigeration may be damaged or the lifetime shortened if the set-point temperature is set above 60°C for more than one hour with the refrigeration manually on. Ensure that the refrigeration is off when the bath is used above 60°C.
- The Factory Reset Sequence should be performed only by authorized personnel if no other action is successful in correcting a malfunction. You must have a copy of the most recent Report of Test to restore the test parameters.
- DO NOT operate this instrument in an excessively wet, oily, dusty, or dirty environment. Silicone oils require additional ventilation to prevent an oily, dirty environment.



- **Most probes have handle temperature limits. Be sure that the probe handle temperature limit is not exceeded in the air above the instrument.**
- **The instrument and any thermometer probes used with it are sensitive instruments that can be easily damaged. Always handle these devices with care. Do not allow them to be dropped, struck, stressed, or overheated.**

#### **COLD BATHS:**

- **Refrigerated baths require that the condensing coil be cleaned periodically. Accumulation of dust and dirt on the condenser will result in premature failure of the compressor.**
- **Bath or compressor lifetime may be affected by:**
  - **Cycling the heat source through extreme temperature ranges (the full temperature limit of the heat source). Cycling the instrument can cause excessive stress on the compressors. Compressor manufacturers recommend, for longest lifetime, that the instrument be set at one temperature and left on at that temperature.**
  - **Turning the instrument on and off frequently adds wear and tear to the compressor.**

### **Authorized Service Centers**

Please contact one of the following authorized Service Centers to coordinate service on your Fluke product:

#### **Fluke Corporation**

799 E. Utah Valley Drive  
American Fork, UT 84003-9775  
USA

Phone: +1.801.763.1600

Telefax: +1.801.763.1010

E-mail: support@hartscientific.com

#### **Fluke Nederland B.V.**

Customer Support Services  
Science Park Eindhoven 5108  
5692 EC Son  
NETHERLANDS

Phone: +31-402-675300

Telefax: +31-402-675321

E-mail: ServiceDesk@fluke.nl

**Fluke Int'l Corporation**

Service Center - Instrimpex  
Room 2301 Sciteck Tower  
22 Jianguomenwai Dajie  
Chao Yang District  
Beijing 100004, PRC  
CHINA

Phone: +86-10-6-512-3436  
Telefax: +86-10-6-512-3437  
E-mail: xingye.han@fluke.com.cn

**Fluke South East Asia Pte Ltd.**

Fluke ASEAN Regional Office  
Service Center  
60 Alexandra Terrace #03-16  
The Comtech (Lobby D)  
118502  
SINGAPORE

Phone: +65 6799-5588  
Telefax: +65 6799-5588  
E-mail: antng@singa.fluke.com

When contacting these Service Centers for support, please have the following information available:

- Model Number
- Serial Number
- Voltage
- Complete description of the problem

## **Chapter 2**

# **Introduction**

The Fluke's 7341 is a compact constant temperature bath useful in temperature calibration and other applications requiring stable temperatures. An innovative state of the art solid-state temperature controller has been incorporated which maintains the bath temperature with extreme stability. The temperature controller uses a micro-controller to execute the many operating functions.

User interface is provided by the 8-digit LED display and four key-switches. Digital remote communications is standard with an RS-232 and optional with an IEEE-488 interface.

The 7341 bath was designed to be compact and low cost without compromising performance. The 7341 bath operates over a wide temperature range from  $-40^{\circ}\text{C}$  to  $150^{\circ}\text{C}$ . The refrigeration permits sub-ambient temperature control.

The 7341 features:

- Rapid heating and cooling
- RS-232 (standard) and IEEE-488 (optional)
- Temperature scan rate control
- Ramp and soak functions
- Compact size
- Eight set-point memory
- Adjustable readout in  $^{\circ}\text{C}$  or  $^{\circ}\text{F}$
- Automatic refrigeration control



**Chapter 3**  
***Specifications and Environmental***  
***Conditions***

<b>Title</b>	<b>Page</b>
Specifications.....	3-3
Environmental Conditions .....	3-4



## Specifications

Table 3-1 describes the product specifications.

**Table 3-1. Specifications**

Item	Description
Range	–45°C to 150°C
<b>Stability (2 sigma)</b>	±0.005°C at –40°C (ethanol) ±0.005°C at 25°C (water) ±0.007°C at 150°C (5012 oil)
<b>Uniformity</b>	±0.007°C at –40°C (ethanol) ±0.007°C at 25°C (water) ±0.010°C at 150°C (5012 oil)
<b>Heating Time*</b>	120 minutes, from 25°C to 150°C (5012 oil @ 115V)
<b>Cooling Time</b>	130 minutes, from 25°C to –45°C (ethanol)
<b>Stabilization Time</b>	15-20 minutes
<b>Temperature Setting</b>	Digital display with push-button entry
<b>Set-point Resolution</b>	0.01°; 0.00018° in high resolution
<b>Display Temperature Resolution</b>	0.01°
<b>Digital Setting Accuracy</b>	±1°C
<b>Digital Setting Repeatability</b>	±0.01°C
<b>Heater</b>	700 Watts @ 115V (230V) Nominal
Access Opening	6.8" x 4.7" (172 x 119 mm)
Immersion Depth	18" (457 mm) without liquid-in-glass thermometer cal kit 19" (482 mm) with liquid-in-glass thermometer cal kit
Wetted Parts	304 Stainless Steel
<b>Power*</b>	115 VAC (±10%), 60 Hz, 16 A, 1660 VA [230 VAC (±10%), 50 Hz, 8 A, 1450 VA, optional] Note: If the voltage is outside ±10%, the compressor may be damaged. Check the back panel label for the correct voltage and frequency prior to energizing the instrument.
<b>System Fuse</b>	115V: 20A 250V slow blow 230V: 10A 250V slow blow
<b>Volume</b>	4.2 gal. (15.9 liters)
<b>Weight</b>	150 lb. (68 kg)
Size (w x f–b x h)	14" W x 31" D x 42" H (356 x 788 x 1067mm); 37" (940 mm) from floor to tank access opening
Safety	OVERVOLTAGE (Installation) CATEGORY II, Pollution Degree 2 per IEC 1010-1
Refrigeration	R-507 single stage
Interface Package	RS-232 included, IEEE-488 optional
*Rated at listed 115 V (or optional 230 V).	

## **Environmental Conditions**

Although the instrument has been designed for optimum durability and trouble-free operation, it must be handled with care. The instrument should not be operated in an excessively dusty or dirty environment. Maintenance and cleaning recommendations can be found in the Maintenance Section of this manual.

The instrument operates safely under the following conditions:

- ambient temperature range: 5–40°C (41–104°F)
- ambient relative humidity: maximum 80% for temperatures < 31°C decreasing linearly to 50% at 40°C
- pressure: 75kPa - 106kPa
- mains voltage within  $\pm 10\%$  of nominal
- vibrations in the calibration environment should be minimized
- altitudes less than 2000 meters
- indoor use only



# **Chapter 4**

## **Quick Start**

<b>Title</b>	<b>Page</b>
Unpacking.....	4-3
Set Up .....	4-3
Power .....	4-5
Setting the Temperature.....	4-5



**⚠ Caution**

**Read Chapter 6 entitled BATH USE before placing the bath in service.**

This chapter gives a brief summary of the steps required to set up and operate the bath. This should be used as a general overview and reference and not as a substitute for the remainder of the manual. Please read Chapter 5, Installation, through Chapter 8, General Operation, carefully before operating the bath.

**Unpacking**

Unpack the bath carefully and inspect it for any damage that may have occurred during shipment. If there is shipping damage, notify the carrier immediately. Verify that all components are present:

- 7341 Bath
- Access Hole Cover
- Fluid Expansion Reservoir with Cover
- User's Guide
- RS-232 Cable
- Report of Test
- Drain Valve
- 9930 Interface-it Software and User's Guide
- Tipping Prevention Bracket, including mounting hardware for wood or concrete floor
- 2019-DCB Kit, Liquid-in-Glass (LIG) Adapter and Carousel (optional)
- 2069 Scope, Liquid-in-Glass (LIG) with mounts (optional)

If you are missing any item, please call an Authorized Service Center. To locate an Authorized Service Center near you see Authorized Service Centers in Chapter 1.

**Set Up****⚠ Warning**

**The instrument is equipped with a soft cutout (user settable firmware) and a hard cutout (set at the factory). Check the flash point, boiling point, or other fluid characteristic applicable to the circumstances of the instrument operation. Ensure that the soft cutout is adjusted to the fluid characteristics of the application. As a guideline, the soft cutout should be set 10°C to 15°C below the flash point of the bath fluid. See Heat Transfer Fluid in Chapter 8, for specific information on bath fluids and Cutout in Chapter 10.**

Set up of the bath requires careful unpacking and placement of the bath, filling the bath with fluid, and connecting power. Consult Chapter 5, Installation, for detailed instructions for proper installation of the bath. Be sure to place the bath in a safe, clean and level location. Refer to Tipping Prevention Bracket in Chapter 5, for Tipping Prevention Bracket installation instructions.

Fill the bath tank with an appropriate liquid. Be sure to select the correct fluid for the temperature range of the calibration. Bath fluids should be selected to operate safely with adequate thermal properties to meet the application requirements. For operation at

moderate bath temperatures, clean distilled water works well. Carefully pour the fluid into the bath tank through the large rectangular access hole above the tank avoiding spilling any fluid.

**⚠ Caution**

**When filling the tank, ensure the immersion coils are completely covered. DO NOT FILL ABOVE THE STIR BAFFLE. See Figure 4-1.**

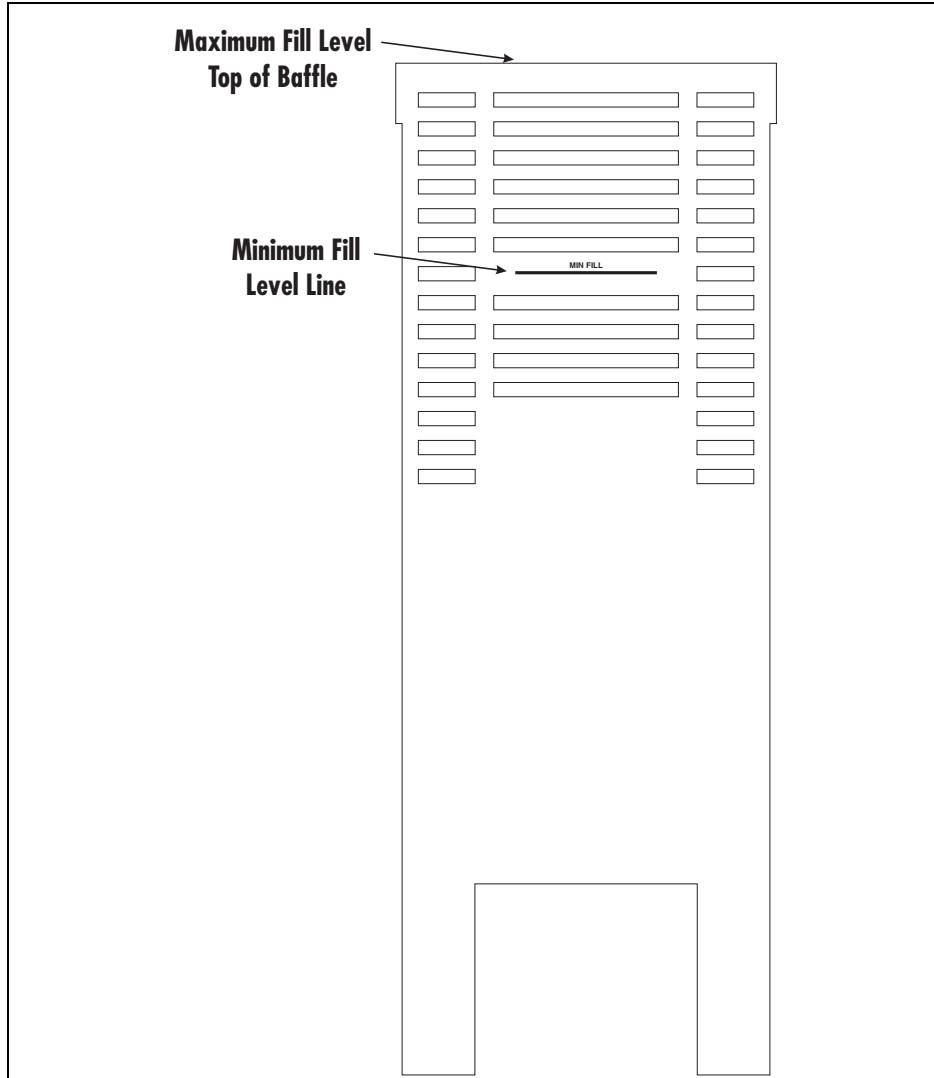

Figure 4-1. Stir Baffle Fill Levels

haz001.eps

An overflow drain is provided for excess bath fluid due to expansion. This drains the fluid into the fluid expansion reservoir for reuse. See Fluid Expansion Reservoir in Chapter 7, for details in using the reservoir.

*Note*

*As the temperature of the bath increases the fluid level will increase, see Chapter 6.*

**Power**

Plug the bath power cord into a mains outlet of the proper voltage, frequency, and current capability. Refer to Specifications in Chapter 3, for power details. Refer to and read the CAUTION at the front of the manual concerning brownout and over voltage protection. **Check the back panel label for the correct voltage and frequency prior to energizing the bath.** Turn the bath on using the front panel “POWER” switch. The bath will turn on and begin to heat or cool to reach the previously programmed temperature set-point. The front panel LED display will indicate the actual bath temperature. Set the cooling switch to “ON” for below or near ambient temperatures.

*Note*

*The actual temperature where cooling is required depends on the bath fluid and whether a cover is used over the access well.*

**Setting the Temperature**

In the following discussion and throughout this manual a solid box around the word SET, UP, DOWN or EXIT indicates the panel button to press while the dotted box indicates the display reading on the front panel. Explanation of the button function or display reading is written at the right.

To view or set the bath temperature set-point proceed as follows. The front panel LED display normally shows the actual bath temperature.

 *Bath temperature display*

When “SET” is pressed the display shows the set-point memory that is currently being used and its value. Eight set-point memories are available.

 *Access set-point selection*

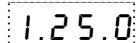
 *Set-point 1, 25.0°C currently used*

Press “SET” to select this memory and access the set-point value.

 *Access set-point value*

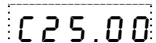
 *Current value of set-point 1, 25.00°C*

Press “UP” or “DOWN” to change the set-point value.

 *Increment display*

 *New set-point value*

Press SET to accept the new value and display the vernier value. The bath begins heating or cooling to the new set-point.



*Store new set-point, access vernier*

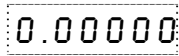

*Current vernier value*

Press "EXIT" and the bath temperature will be displayed again.



*Return to the temperature display*

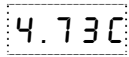

*Bath temperature display*

The bath heats or cools until it reaches the new set-point temperature. Turn off the cooling to reach and control at higher temperatures.

When setting the set-point temperature be careful not to exceed the temperature limit of the bath fluid. The over-temperature cutout should be correctly set for added safety. See Cutout in Chapter 10.

To obtain optimum control stability adjust the proportional band as discussed in Proportional Band in Chapter 9.

# **Chapter 5**

## ***Installation***

<b>Title</b>	<b>Page</b>
Moving or Uncrating the Bath .....	5-3
Bath Environment .....	5-3
Tipping Prevention Bracket Installation .....	5-3
Installation On A Wood Floor .....	5-3





**⚠ Caution**

**Read Chapter 6 BATH USE before placing the bath into service.**

**Moving or Uncrating the Bath**

The bath is equipped with casters and should be rolled. It is not equipped with handles and is not designed to be lifted.

When uncrating the bath, remove all of the accessories from the packing foam around the bath. Remove the pre-formed foam. Gently ease the bath from the crate using the casters to roll the bath. If it is required to lift the bath slightly to release it from the crate, two people should carefully slide their hands under the bath and gently lift the bath only enough to clear the packing foam and roll the bath from the crate. The area containing the compressor will be heavier than the rest of the bath.

If it is required to move the bath after installation, empty the bath of fluid. **DO NOT move a bath filled with fluid.** Unlock the casters and roll the bath. Do not attempt to carry the bath. It is tall and heavy and is not provided with handles. Personal injury or damage to the bath may occur.

**Bath Environment**

The Model 7341 Bath is a precision instrument, which should be located in an appropriate environment. The location should be free of drafts, extreme temperatures and temperature changes, dirt, etc. The surface where the bath is placed must be level. Provide at least 6 inches (15 cm) of clearance around the instrument to allow sufficient air circulation.

The top surface of the bath may become hot at high temperatures. Beware of the danger of accidental fluid spills.

A fume hood or other adequate ventilation system should be used to remove any vapors given off by hot bath fluid. Silicone oils require additional ventilation to prevent an oily, dirty environment.

**Tipping Prevention Bracket Installation**

In order to create the safest possible conditions under use, your bath comes equipped with a tipping prevention bracket. The installation of the bracket is required for compliance with the international safety standard IEC 1010-1 (see Stability in Chapter 7) that applies to the stability of the bath under normal operating conditions.

**Installation On A Wood Floor**

The wood floor installation kit includes lag bolts. Drill three 1/8 inch x 1 inch deep (approximately 3 mm x 25.5 mm) pilot holes using the tipping bracket to mark the hole placement. Use the lag bolts to install the bracket to the floor. Ensure that the bracket is installed in such a way that the bath will have a minimum 6 inches of clearance for air circulation. (See Figure 5-1). Screw the bracket securely to the floor.

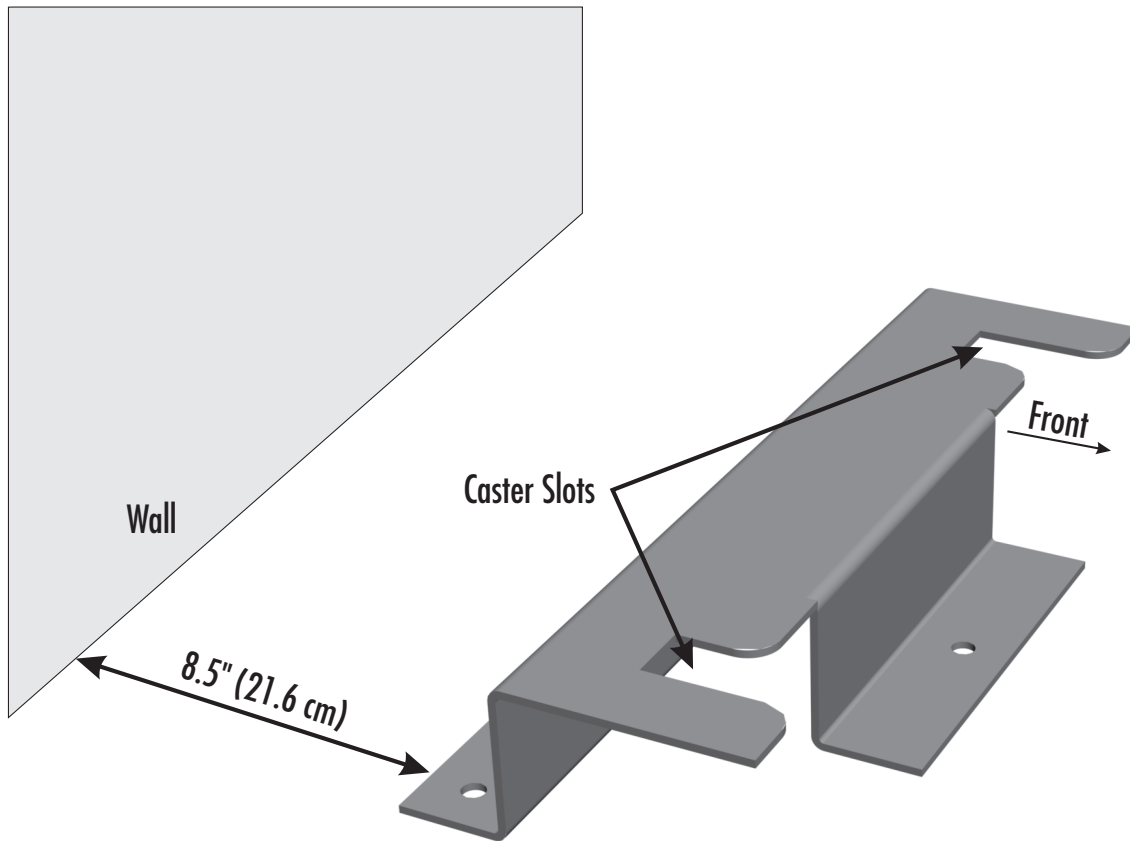

Figure 5-1. Tipping Prevention Bracket Installation

haz002.eps

### **Installation On a Concrete Floor**

Using a concrete drill and concrete drill bit, drill three ¼ inch x 1 ¼ inch deep (approximately 6.5 mm x 32 mm) holes in the concrete floor using the bracket to mark the hole placement. Drop the flare anchor bolt into the hole. Tightening the screw expands the anchor in the drilled hole and secures the tipping bracket. Ensure that the bracket is installed in such a way that the bath will have a minimum of 6 inches of clearance for air circulation. (See Figure 5-1). Screw the bracket securely to the floor.

### **Installation Of The Bath**

Slide the back casters of the bath completely into the tipping bracket. Lock the front casters of the bath. Check that the bath is securely locked into the tipping bracket by gently pushing on the bath. Proceed to fill the bath with the applicable bath fluid after reading the entire Users Guide.

If you have any questions concerning installation of the tipping prevention bracket, please contact a Fluke Authorized Service Center.

### **“Dry-out” Period**

If this equipment is used in a manner not specified by the manufacturer, the protection provided by the equipment may be impaired.

Before initial use, or after transport, or after storage in humid or semi-humid environments, or anytime the bath has not been energized for more than 10 days, the instrument needs to be energized for a "dry-out" period of 2 hours before it can be assumed to meet all of the safety requirements of the IEC 1010-1. If the product is wet or has been in a wet environment, take necessary measures to remove moisture prior to

applying power such as storage in a low humidity temperature chamber operating at 50°C for 4 hour or more.

## **Bath Preparation and Filling**

### **⚠ Caution**

**Avoid spilling fluid over the control panel. Immediately clean up any spilling. Cover the panel if necessary during filling. DO NOT overfill.**

The Model 7341 Bath is not provided with a fluid. Various fluids are available from Hart and other sources. Depending on the desired temperature range, any of the following fluids, as well as others, may be used in the bath:

- Water
- Ethylene glycol/water
- Mineral oil
- Silicone oil
- Ethanol

Fluids are discussed in detail in Heat Transfer Fluid in Chapter 8.

Remove any access hole cover from the bath and check the tank for foreign matter (dirt, remnant packing material, etc.).

Fill the bath with clean unpolluted fluid. Fill the bath carefully through the large rectangular access hole to a level that will allow for stirring and thermal expansion. Thermal Expansion in Chapter 8, explains fluid expansion.

### **⚠ Caution**

**DO NOT turn on the bath without fluid in the tank and the heating coils fully immersed. See Fluid Expansion Reservoir in Chapter 7, on how to use the fluid expansion reservoir.**

Be sure the fluid expansion reservoir is properly installed checking to insure it is clean and free of foreign matter. Carefully monitor the bath fluid level as the bath temperature rises to prevent excessive overflow or splashing. Remove excess hot fluid if necessary with caution.

## **Power**

With the bath power switch off, plug the bath into an AC mains outlet of the appropriate voltage, frequency, and current capacity. Refer to Specifications in Chapter 3, for power details. Refer to and read the CAUTION at the front of the manual concerning brownout and over voltage protection. **Check the back panel label for the correct voltage and frequency prior to energizing the bath.**



# **Chapter 6**

## ***Bath Use***

<b>Title</b>	<b>Page</b>
General.....	6-3
Comparison Calibration.....	6-3
Calibration of Multiple Probes.....	6-4



**⚠ Caution**

**Read this chapter entitled BATH USE before placing the bath in service.**

The information in this section is for general information only. It is not designed to be the basis for calibration laboratory procedures. Each laboratory needs to write their specific procedures.

**General**

Be sure to select the correct fluid for the temperature range of the calibration. Bath fluids should be selected to operate safely with adequate thermal properties to meet the application requirements. Also, be aware that fluids expand when heated and could overflow the bath if not watched. Refer to Chapter 8, General Operation, for information specific to fluid selection and to the MSDS sheet specific to the fluid selected. Generally, baths are set to one temperature and used to calibrate probes only at that single temperature. This means that the type of bath fluid does not have to change. Additionally, the bath can be left energized reducing the stress on the system.

The bath generates extreme temperatures. Precautions must be taken to prevent personal injury or damage to objects. Probes may be extremely hot or cold when removed from the bath. Cautiously handle probes to prevent personal injury. Carefully place probes on a heat/cold resistant surface or rack until they are at room temperature. It is advisable to wipe the probe with a clean soft cloth or paper towel before inserting it into another bath. This prevents the mixing of fluids from one bath to another. If the probe has been calibrated in liquid salt, carefully wash the probe in warm water and dry completely before transferring it to another fluid. Always be sure that the probe is completely dry before inserting it into a hot fluid. Some high temperature fluids react violently to water or other liquid mediums. Be aware that cleaning the probe can be dangerous if the probe has not cooled to room temperature. Additionally, high temperature fluids may ignite the paper towels if the probe has not been sufficiently cooled.

For optimum accuracy and stability, allow the bath adequate stabilization time after reaching the set-point temperature.

**Comparison Calibration**

Comparison calibration involves testing a probe (unit under test, UUT) against a reference probe. After inserting the probes to be calibrated into the bath, allow sufficient time for the probes to settle and the temperature of the bath to stabilize.

One of the significant dividends of using a bath rather than a dry-well to calibrate multiple probes is that the probes do not need to be identical in construction. The fluid in the bath allows different types of probes to be calibrated at the same time. However, stem effect from different types of probes is not totally eliminated. Even though all baths have horizontal and vertical gradients, these gradients are minimized inside the bath work area. Nevertheless, probes should be inserted to the same depth in the bath liquid. Be sure that all probes are inserted deep enough to prevent stem effect. From research at Hart Scientific, we suggest a general rule-of-thumb for immersion depth to reduce the stem effect to a minimum:  $20 \times$  the diameter of the UUT + the sensor length. Do not submerge the probe handles. If the probe handles get too warm during calibration at high temperatures, a heat shield could be used just below the probe handle. This heat shield could be as simple as aluminum foil placed around the handle or as complicated as a specially designed reflective metal apparatus.

When calibrating over a wide temperature range, starting at the highest temperature and progressing down to the lowest temperature can generally achieve better results.

Probes can be held in place in the bath by using probe clamps or drilling holes in the

access cover. Other fixtures to hold the probes can be designed. The object is to keep the reference probe and the probe(s) to be calibrated as closely grouped as possible in the working area of the bath. Bath stability is maximized when the bath working area is kept covered.

In preparing to use the bath for calibration start by:

- Placing the reference probe in the bath working area.
- Placing the probe to be calibrated, the UUT, in the bath working area as close as feasibly possible to the reference probe but not touching the bath tank surface areas.

### ***Calibration of Multiple Probes***

Fully loading the bath with probes increases the time required for the temperature to stabilize after inserting the probes. Using the reference probe as the guide ensures that the temperature has stabilized before starting the calibration.



# **Chapter 7**

## ***Parts and Controls***

<b>Title</b>	<b>Page</b>
Front Control Panel.....	7-3
Back Panel .....	7-3
Fluid Expansion Reservoir.....	7-3



## Front Control Panel

The following controls and indicators are present on the controller front panel (see Figure 7-1): (1) the digital LED display, (2) the control buttons, (3) the bath on/off power switch, (4) the control indicator light, and (5) the cooling on/off switch.

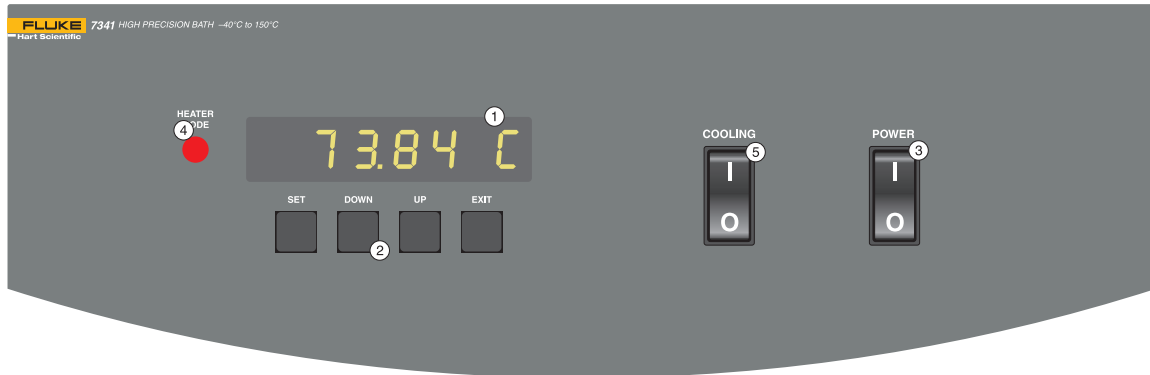

Figure 7-1. Front Control Panel

haz003.eps

1. The digital display is an important part of the temperature controller. It displays the set-point temperature and bath temperature as well as the various other bath functions, settings, and constants. The display shows temperatures according to the selected scale units °C or °F.
2. The control buttons (SET, DOWN, UP, and EXIT) are used to set the bath temperature set-point, access and set other operating parameters, and access and set bath calibration parameters. A brief description of the functions of the buttons follows:
  - SET - Used to display the next parameter in a menu and to set parameters to the displayed value.
  - DOWN - Used to decrement the displayed value of parameters.
  - UP - Used to increment the displayed value.
  - EXIT - Used to exit from a menu. When EXIT is pressed any changes made to the displayed value will be ignored.
3. The on/off switch controls power to the entire bath including the stirring motor.
4. The control indicator is a two color light emitting diode (LED). This indicator lets the user visually see the ratio of heating to cooling. When the indicator is red the heater is on, and when it is green the heater is off and the bath is cooling.
5. The cooling switch turns on the refrigeration for control below 50°C and rapid cool down. The cooling shuts off automatically above 60°C. Manually turn off the refrigeration at temperatures where it has been determined to be unnecessary. See Refrigeration (Chapter 8), Cooling Mode (Chapter 9), and Hot Gas Bypass Mode (Chapter 9).

## Back Panel

On the back of the bath are the system fuses, power cord, high/low voltage indicator, drain, serial port, IEEE-488 port (if installed), and the fluid expansion reservoir.

## Fluid Expansion Reservoir

The fluid expansion reservoir is attached to the rear panel of the bath. Its purpose is to

receive excess fluid expanded in the process of heating the bath to higher temperatures. Any liquid will expand when heated. To prevent the bath from overflowing when the fluid expands, the excess fluid must be removed either prior to heating or by allowing it to drain out of the bath tank.

*Note*

*The fluid level must never be below the heating elements.*

This bath has an overflow tube attached to the bath tank that extends to the rear of the bath and drains into the fluid expansion reservoir. The reservoir has enough capacity to cover a large range of thermal expansion rates for different fluids. No attempt must be made to plug the overflow tube to prevent fluid from draining. Do not attempt to fill the bath to a level higher than the overflow tube level.

The fluid expansion reservoir is stainless steel with an aluminum heat shield to prevent touching when the tank is hot. There is a stainless steel dust cover over the reservoir with an elbow on top that the drain tube is inserted into. The reservoir hangs on a hook and is attached to the bath with a thumbscrew.

**⚠Warning**

**The drain tube and dust cover may be hot. Always be sure the drain tube is fully inserted into the elbow of the dust cover.**

To drain fluid from the reservoir, first remove the dust cover and set aside. Then undo the thumbscrew and carefully lift it with the two handles provided on the back. The fluid may then be poured back into the bath when it is cooler or poured into some other approved container. Caution: Be careful when handling hot fluids, burns can result. When the excess fluid has been removed, reverse the process to replace the reservoir and dust cover. Always wipe away spilt fluid if spilling occurs.

**⚠Warning**

The overflow tube is not large enough to handle large flow rates encountered by overfilling the tank. It is intended for expanding fluid rates from heating only. Fill only until the level reaches the top of the stir baffle (see Figure 4-1).

# Chapter 8

## General Operation

Title	Page
Heat Transfer Fluid.....	8-3
Temperature Range.....	8-3
Viscosity.....	8-3
Specific Heat.....	8-3
Thermal Conductivity.....	8-3
Thermal Expansion.....	8-3
Electrical Resistivity.....	8-4
Fluid Lifetime.....	8-4
Safety.....	8-4
Cost.....	8-5
Commonly Used Fluids.....	8-5
Water.....	8-5
Ethylene Glycol.....	8-5
Mineral Oil.....	8-5
Silicone Oil.....	8-6
Fluid Characteristics Charts.....	8-6
Limitations and Disclaimer.....	8-6
About the Chart.....	8-8
Stirring.....	8-10
Power.....	8-10
Heater.....	8-10
Temperature Controller.....	8-10
Refrigeration.....	8-11



## Heat Transfer Fluid

Many fluids will work with 7341 bath. Choosing a fluid requires consideration of many important characteristics of the fluid. Among these are temperature range, viscosity, specific heat, thermal conductivity, thermal expansion, electrical resistivity, fluid lifetime, safety, and cost.

Use the fluid chart in the manual to choose the type of fluid that is best suited for you intended purpose.

### Temperature Range

One of the most important characteristics to consider is the temperature range of the fluid. Few fluids work well throughout the entire temperature range of the bath. The temperature at which the bath is operated must always be within the safe and useful temperature range of the fluid used. The lower temperature range of the fluid is determined either by the freeze point of the fluid or the temperature at which the viscosity becomes too great. The upper temperature is usually limited by vaporization, flammability, or chemical breakdown of the fluid. Vaporization of the fluid at higher temperatures may adversely affect temperature stability because of cool condensed fluid dripping into the bath from the lid.

The bath temperature should be limited by setting the safety cutout (see Cutout in Chapter 9) or the high limit (see Calibration Parameters in Chapter 9) so that the bath temperature cannot exceed the safe operating temperature limit of the fluid.

### Viscosity

Viscosity is a measure of the thickness of a fluid or how easily it can be poured and mixed. Viscosity affects the temperature uniformity and stability of the bath. With lower viscosity fluid mixing is better. This creates a more uniform temperature throughout the bath. This improves the bath response time allowing it to maintain a more constant temperature. For good control the viscosity should be less than 10 centistokes. 50 centistokes is the practical upper limit of allowable viscosity. Viscosity greater than this causes very poor control stability because of poor stirring and may also overheat or damage the stirring motor.

Viscosity may vary greatly with temperature, especially with oils. Viscosity increases as temperature decreases. When fluid viscosity increases, stability performance of the unit may decrease. Ensure that stirring occurs at all temperatures.

When using fluids with higher viscosities the controller proportional band (see Proportional Band in Chapter 9) may need to be increased to compensate for the reduced response time. Otherwise the temperature may begin to oscillate.

### Specific Heat

Specific heat is the measure of the heat storage ability of the fluid. Specific heat, to a small degree, affects the control stability and the heating and cooling rates. Generally, a lower specific heat means quicker heating and cooling. The proportional band may require some adjustment depending on the specific heat of the fluid.

### Thermal Conductivity

Thermal conductivity measures how easily heat flows through the fluid. Thermal conductivity of the fluid affects the control stability, temperature uniformity, and temperature settling time. Fluids with higher conductivity distribute heat more quickly and evenly improving bath performance.

### Thermal Expansion

Thermal expansion describes how much the volume of the fluid changes with temperature. Thermal expansion of the fluid must be considered since the increase in

fluid volume as the bath temperature increases may cause overflow. It may be dangerous to permit the fluid to overflow the tank. It may also cause loss of valuable bath fluid. Excessive thermal expansion may also be undesirable in applications where constant liquid level is important.

Thermal expansion coefficients of several fluids are shown in Table 8-1. Fluid manufacturers can also provide this information. The thermal expansion coefficients are shown in units of cm/cm/°C. However, the values are the same for any unit of length. Divide the value by 1.8 for °F coefficients. The following equation may be used to find the desired depth:

$$D_E = D_S [K(T_E - T_S) + 1]$$

Or

$$D_S = D_E / [K(T_E - T_S) + 1] \text{ where } D_E \leq \text{The Maximum Fill Depth}$$

Where:

K=Expansion coefficient

T<sub>E</sub>=Ending temperature

T<sub>S</sub>=Starting temperature

D<sub>E</sub>=Ending depth

D<sub>S</sub>=Starting depth

The maximum fill depth is typically 0.5 to 0.8 inches below the level of the gasket at the top of the bath tank (not the top of the bath lid). Judgment must be made with different stirring arrangements to prevent splashing on the gasket or lid of the bath.

Example:

The final depth of Dow Corning 710 silicone oil in the bath tank is to be 9.2 inches when heated from 25 to 300°C. What should the starting depth be?

Expansion coefficient for 710 oil on Table 2, K= 0.00077 inch/inch/°C

Ending temperature, T<sub>E</sub> = 300°C

Starting temperature, T<sub>S</sub> = 25°C

Ending depth, D<sub>E</sub> = 9.2 inches

$$D_S = 9.2 / [0.00077 (300 - 25) + 1] = 7.59 \text{ inches}$$

### **Electrical Resistivity**

Electrical resistivity describes how well the fluid insulates against the flow of electric current. In some applications, such as measuring the resistance of bare temperature sensors, it may be important that little or no electrical leakage occur through the fluid.

In such conditions choose a fluid with very high electrical resistivity.

### **Fluid Lifetime**

Many fluids degrade over time because of vaporization, water absorption, gelling, or chemical break-down. Often the degradation becomes significant near the upper temperature limit of the fluid, substantially reducing the fluid's lifetime.

### **Safety**

When choosing a fluid always consider the safety issues associated. Obviously where there are extreme temperatures there can be danger to personnel and equipment. Fluids may also be hazardous for other reasons. Some fluids may be considered toxic. Contact with eyes, skin, or inhalation of vapors may cause injury. A proper fume hood or



adequate ventilation system must be used if hazardous or bothersome vapors are produced.

### **⚠ Warning**

**Fluids at high temperatures may pose danger from BURNS, FIRE, and TOXIC FUMES. Use appropriate caution and safety equipment.**

Fluids may be flammable and require special fire safety equipment and procedures. An important characteristic of the fluid to consider is the flash point. The flash point is the temperature at which there is sufficient vapor given off so that when there is adequate oxygen present and an ignition source is applied the vapor will ignite. This does not necessarily mean that fire will be sustained at the flash point. The flash point may be either of the open cup or closed cup type. Either condition may occur in a bath situation. The open cup flash point is measured under the condition of vapors escaping the tank. The closed cup flash point is measured with the vapors being contained within the tank. Since oxygen and an ignition source is less available inside the tank the closed cup flash point will be lower than the open cup flash point.

Environmentally hazardous fluids require special disposal according to applicable federal or local laws after use.

### **Cost**

Cost of bath fluids may vary greatly, from cents per gallon for water to hundreds of dollars per gallon for synthetic oils. Cost may be an important consideration when choosing a fluid.

### **Commonly Used Fluids**

Below is a description of some of the more commonly used fluids and their characteristics.

#### **Water**

Water is often used because of its very low cost, its availability, and its excellent temperature control characteristics. Water has very low viscosity and good thermal conductivity and heat capacity, which make it among the best fluids for good control stability at lower temperatures. Temperature stability is much poorer at higher temperatures because water condenses on the lid, cools and drips into the bath. Water is safe and relatively inert. The electrical conductivity of water may prevent its use in some applications. Water has a limited temperature range, from a few degrees above 0°C to a few degrees below 100°C. At higher temperatures evaporation becomes significant. Water used in the bath should be distilled or deionized to prevent mineral deposits. Consider using an algicide chemical in the water to prevent contamination.

#### *Note*

*Water used at temperatures greater than 75°C (167°F) may have stability problems.*

#### **Ethylene Glycol**

The temperature range of water may be extended by using a solution of one part water and one part ethylene glycol (antifreeze). The characteristics of the ethylene glycol-water solution are similar to water but with higher viscosity. Use caution with ethylene glycol since this fluid is very toxic. Ethylene glycol must be disposed of properly.

#### **Mineral Oil**

Mineral oil or paraffin oil is often used at moderate temperatures above the range of water. Mineral oil is relatively inexpensive. At lower temperatures mineral oil is quite viscous and control may be poor. At higher temperatures vapor emission becomes

significant. The vapors may be dangerous and a fume hood or adequate ventilation system should be used. As with most oils, mineral oil expands as temperature increases. Be careful not to fill the bath too full to avoid overflows when heated (see Fluid Expansion Reservoir in Chapter 7). The viscosity and thermal characteristics of mineral oil is poorer than water so temperature stability will not be as good. Mineral oil has very low electrical conductivity. Use caution with mineral oil since it is flammable and may also cause serious injury if inhaled or ingested.

### *Silicone Oil*

Silicone oils are available which offer a much wider operating temperature range than mineral oil. Like most oils, silicone oils have temperature control characteristics, which are somewhat poorer than water. The viscosity changes significantly with temperature and thermal expansion also occurs. These oils have very high electrical resistivity. Silicone oils are fairly safe and non-toxic, but can be fairly expensive.

### *Fluid Characteristics Charts*

#### **⚠ Caution**

**Due to the unique properties of silicone oils and their ability to migrate and creep through seals, adequate ventilation must be used to prevent oil vapors from creating an oily, dirty environment. Oily, dirty environments reduce the lifetime of the instruments electrical components.**

Table 8-1 and Figure 8-1 have been created to provide help in selecting a heat exchange fluid media for your constant temperature bath. These charts provide both a visual and numerical representation of most of the physical qualities important in making a selection. The list is not all inclusive. There may be other useful fluids not shown in this listing. The charts include information on a variety of fluids, which are often used as heat transfer fluid in baths. Because of the temperature range some fluids may not be useful with your bath.

### *Limitations and Disclaimer*

The information given in this manual regarding fluids is intended only to be used as a general guide in choosing a fluid. Though every effort has been made to provide correct information we cannot guarantee accuracy of data or assure suitability of a fluid for a particular application. Specifications may change and sources sometimes offer differing information. Fluke cannot be liable for any personal injury or damage to equipment, product or facilities resulting from the use of these fluids. The user of the bath is responsible for collecting correct information, exercising proper judgment, and insuring safe operation. Operating near the limits of certain properties such as the flash point or viscosity can compromise safety or performance. Your company's safety policies regarding flash points, toxicity, and such issues must be considered. You are responsible for reading the MSDS (material safety data sheets) and acting accordingly.

**Table 8-1. Various Bath Fluids and Their Properties**

Fluid (# = PN)	Lower Temp. Limit*	Upper Temp. Limit*	Flash Point	Viscosity (centistokes)	Specific Gravity	Specific Heat (cal/g/°C)	Thermal Conductivity (cal/s/cm/°C)	Thermal Expansion (cm/cm/°C)	Resistivity (1012Ω-cm)
Halocarbon 0.8 #5019	-100°C (v)**	70°C (e)	NONE	5.7@-50°C 0.8@40°C 0.5@70°C	1.71@40°C	0.2	0.0004	0.0011	
Methanol	-96°C (fr)	10°C (fl, cc)	12°C	1.3@-35°C 0.66@0°C 0.45@20°C	0.810@0°C 0.792@20°C	0.6	0.0005@20°C	0.0014@25°C	
Water	0°C (fr)	95°C (b)	NONE	1@25°C 0.4@75°C	1.00	1.00	0.0014	0.0002@25°C	
Ethylene Glycol— 50% #5020	-30°C (fr)	90°C (b)	NONE	7@0°C 2@50°C 0.7@100°C	1.05	0.8@0°C	0.001		
Mineral Oil No.7 #5011	10°C (v)	166°C (fl)	168°C	15@75°C 5@125°C	0.87@25°C 0.84@75°C 0.81@125°C	0.48@25°C 0.53@75°C 0.57@125°C	0.00025@25°C	0.0007@50°C	5@25°C
Silicone Oil Type 200.05 #5010	-40°C (v)**	130°C (fl, cc)	133°C	5@25°C	0.92@25°C	0.4	0.00028@25°C	0.00105	1000@25°C 10@150°C
Silicone Oil Type 200.10 #5012	-30°C (v)**	209°C (fl, cc)	211°C	10@25°C 3@135°C	0.934@25°C	0.43@40°C 0.45@100°C 0.482@200°C	0.00032@25°C	0.00108	1000@25°C 50@150°C
Silicone Oil Type 200.20 #5013	10°C (v)	230°C (fl, cc)	232°C	20@25°C	0.949@25°C	0.370@40°C 0.393@100°C 0.420@200°C	0.00034@25°C	0.00107	1000@25°C 50@150°C
Silicone Oil Type 200.50 #5014	30°C (v)	278°C (fl, cc)	280°C	50@25°C	0.96@25°C	0.4	0.00037@25°C	0.00104	1000@25°C 50@150°C
Silicone Oil Type 550 #5016	70°C (v)	230°C (fl, cc) 300°C (fl, oc)	232°C	50@70°C 10@104°C	1.07@25°C	0.358@40°C 0.386@100°C 0.433@200°C	0.00035@25°C	0.00075	100@25°C 1@150°C
Silicone Oil Type 710 #5017	80°C (v)	300°C (fl, oc)	302°C	50@80°C 7@204°C	1.11@25°C	0.363@40°C 0.454@100°C 0.505@200°C	0.00035@25°C	0.00077	100@25°C 1@150°C
Silicone Oil Type 210-H	66°C (v)	313°C (fl, oc)	315°C	50@66°C 14@204°C	0.96@25°C	0.34@100°C	0.0003	0.00095	100@25°C 1@150°C
Heat Transfer Salt #5001	180°C (fr)	550°C	NONE	34@150°C 6.5@300°C 2.4@500°C	2.0@150°C 1.9@300°C 1.7@500°C	0.33	0.0014	0.00041	1.7 Ω/cm <sup>3</sup>

\*Limiting Factors — b - boiling point e - high evaporation fl - flash point fr - freeze point v - viscosity — Flash point test oc = open cup cc = closed cup

\*\*Very low water solubility, ice will form as a slush from condensation below freezing.

### *About the Chart*

The fluid chart visually illustrates some of the important qualities of the fluids shown.

**Temperature Range:** The temperature scale is shown in degrees Celsius. The shaded bands indicate the fluids' general range of application. Qualities including pour point, freeze point, important viscosity points, flash point, boiling point and others may be shown.

**Freezing Point:** The freezing point of a fluid is an obvious limitation to stirring.

As the freezing point is approached high viscosity may also limit performance.

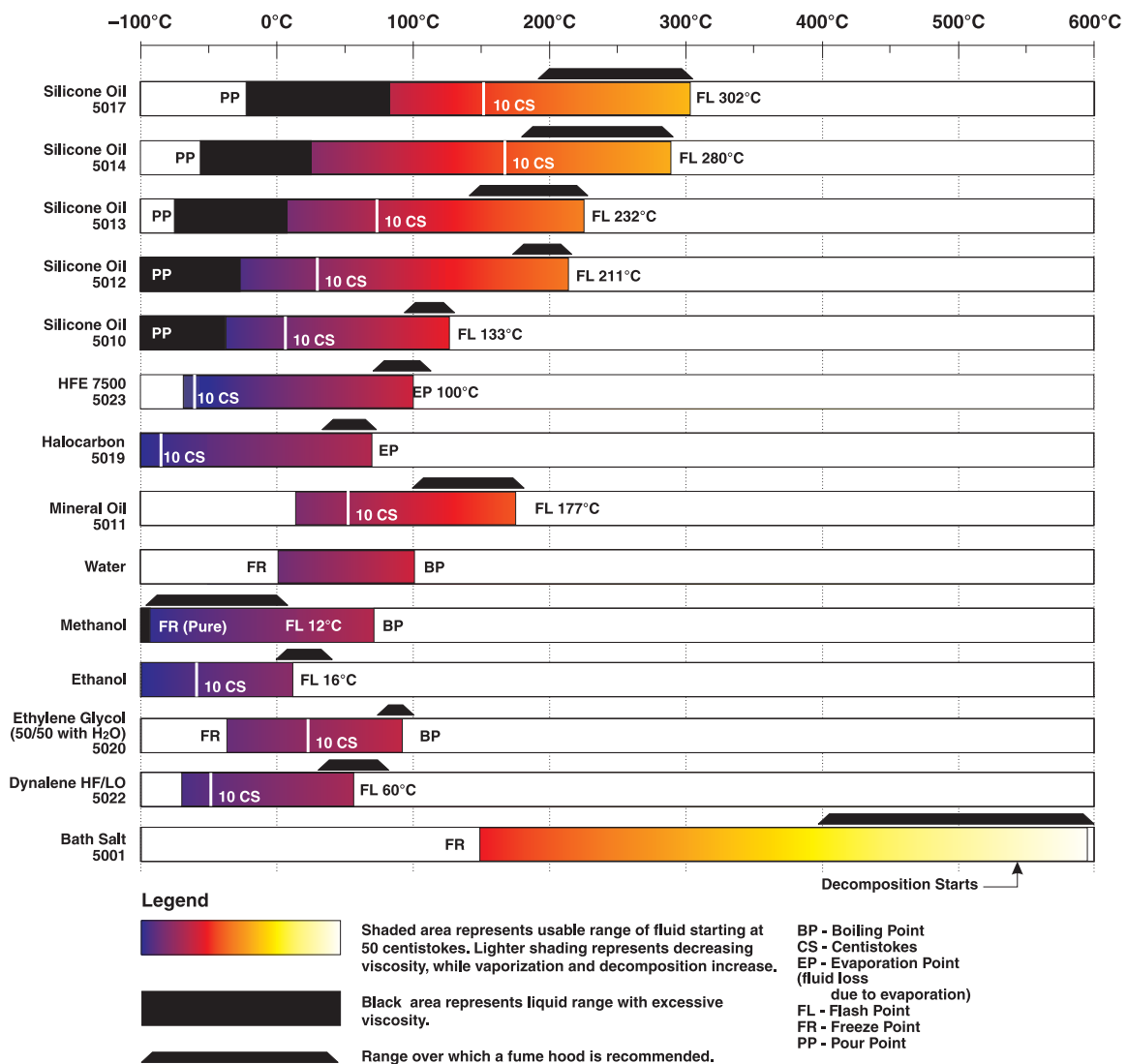

Figure 8-1. Chart of Various Bath Fluids and Their Properties

haz004.eps

**Pour Point:** This represents a handling limit for the fluid.

**Viscosity:** Points shown are at 50 and 10 centistokes viscosity. When viscosity is greater than 50 centistokes stirring is very poor and the fluid is unsatisfactory for bath applications. Optimum stirring generally occurs at 10 centistokes and below.

**Fume Point:** Indicates the point at which a fume hood or ventilation system must be used to prevent health hazards posed by fume vapors. In the graph, it is assumed that the bath access hole is covered at this point. This is subject to user's company policy. Fluke recommends the use of a ventilation system as soon as the fluid produces vapors. Keep the access hole covered to reduce evaporation.

**Flash Point:** The point at which ignition may occur. The point shown may be either the open or closed cup flash point. Refer to the flash point discussion in Safety in Chapter 8.

**Boiling Point:** At or near the boiling point of the fluid the temperature stability is difficult to maintain. Fuming or evaporation is excessive. Large amounts of heater power may be required to maintain the temperature because of the heat of vaporization.

**Decomposition:** The temperature may reach a point at which decomposition of the fluid begins. Further increasing the temperature may accelerate decomposition to the point of danger or impracticality. Silicone oils can oxidize, causing the fluid to thicken. Replace at the first sign of increasing viscosity.

## Stirring

Stirring the bath fluid is very important for stable temperature control. The fluid must be mixed well for good temperature uniformity and fast controller response. The stirrer is precisely adjusted for optimum performance.

## Power

Power to the bath is provided by an AC mains supply. Refer to Specifications in Chapter 3, for power details. Refer to and read the CAUTION at the front of the manual concerning brownout and over voltage protection. **Check the back panel label for the correct voltage and frequency prior to energizing the bath.** Power to the bath passes through a filter to prevent switching spikes from being transmitted to other equipment.

To turn on the bath press the control panel power switch to the ON position. The stirring motor will turn on, the LED display will begin to show the bath temperature, and the heater will turn on or off until the bath temperature reaches the programmed set-point.

When powered on, the control panel display will briefly show a four digit number. This number indicates the number of times power has been applied to the bath. Also briefly displayed is data, which indicates the controller hardware configuration. This data is used in some circumstances for diagnostic purposes.

## Heater

The temperature controller precisely controls the bath heater to maintain a constant bath temperature. Power is controlled by periodically switching the heater on for a certain amount of time using a solid-state relay.

The front panel red/green control indicator shows the state of the heater. The control indicator glows red when the heater is on and green when the heater is off. The indicator pulses at a constant rate when the bath is maintaining a stable temperature.

## Temperature Controller

Fluke's unique hybrid digital/analog temperature controller controls the bath temperature. The controller offers the tight control stability of an analog temperature controller as well as the flexibility and programmability of a digital controller.

The bath temperature is monitored using a platinum resistance sensor as the control probe. The signal is electronically compared with the programmable reference signal, amplified, and then passed to a pulse-width modulator circuit that controls the amount of power applied to the bath heater. The bath is operable within the temperature range given in the specifications. For protection against a solid-state relay failure or other circuit failure, the micro-controller automatically turns off the heater with a second mechanical relay anytime the bath temperature is more than a certain amount above the set-point temperature. In addition to this protection, the controller is also equipped with a separate thermocouple temperature monitoring circuit that shuts off the heater if the temperature exceeds the cutout set-point.

The controller allows the operator to set the bath temperature with high resolution, set the cutout temperature, adjust the proportional band, monitor the heater output power, and program the controller configuration and calibration parameters. The controller may be operated in temperature units of degrees Celsius or Fahrenheit. The controller is operated and programmed from the front control panel using the four key switches and digital

LED display. Remote digital operation with the controller is possible via the standard RS-232 serial port. The controller may be optionally equipped with an IEEE-488 GPIB digital interface. Operation of the controller using the front control panel is discussed following in Chapter 9, Controller Operation. Operation using the digital interface is discussed in Chapter 10, Digital Communication Interface.

When the controller is set to a new set-point, the bath heats or cools to the new temperature. Once the new temperature is reached, the bath usually takes 15–20 minutes for the temperature to settle and stabilize. There may be a small overshoot or undershoot of about 0.5°C during this process.

## Refrigeration

Cooling is provided by a compact refrigeration system utilizing the ozone safe R-507 HFC refrigerant. Refrigeration is often not needed when the bath is above 45 to 60°C. The automated system automatically turns the system off when above 60°C. The refrigeration system automatically changes modes depending upon bath temperature and operation needs as described below. The refrigeration system is activated when the switch on the front panel is turned on.

If the bath is below the 60°C cutoff point and is set to a temperature above 60°C, the refrigeration shuts off to protect it from overheating and creating excessive internal pressures. If the bath is above 60°C and is set to a new temperature below the cutoff temperature, the refrigeration turns on again at 59°C.

When the bath is controlling at temperatures between the 60°C and 0°C, the bath operates in a low cooling capacity mode with the hot gas bypass valve on (HGb on). The HGb system reduces the cooling capacity and helps to improve the bath stability within that temperature range. Since more cooling capacity is generally required below 0°C, the hot gas bypass is turned off (HGb off) providing more cooling capacity.

When the bath is cooled from temperatures below the cutoff point to 0°C and if the new set-point is at least 2°C below the current bath temperature, the cooling turns to maximum capacity (HGb off) until the bath is within about 0.5°C of the new set-point. This provides the fastest cooling possible to achieve the new set-point temperature. As indicated, the cooling is always maximum below 0°C.

When heating the bath from temperatures of –40°C and the new set-point is at least 10°C above the current bath temperature, the refrigeration turns off until the bath is about 1°C below the new set-point. This permits the maximum heating rate to reach the higher temperatures as quickly as possible. The cooling remains off at temperatures above 60°C.

The automatic cooling mode may not be ideal for all circumstances. The automatic mode may be turned off permitting manual control. These controls are available through the front panel as described in Operating Parameters in Chapter 9, or through the digital interface as described in Interface Commands and Cooling Control in Chapter 10. The cooling mode control may be set to automatic, on, or off. With these selections the refrigeration is either in automatic as described above, always on, or always off. The hot gas bypass modes are similarly selectable between automatic, on, or off. This system is either in automatic as described above, always on (low cooling capacity) or always off (high cooling capacity).

The following situations benefit by changing cooling modes.

- If the scan mode has been selected and the desired cooling scan requires maximum cooling capacity in a range where the hot gas bypass would normally be on.
- The application requires maximum cooling capacity when the hot gas bypass would normally be on.
- When using the bath at temperatures below 0°C in an ambient of less than 23°C, a

small benefit to stability may be realized by using the hot gas bypass.

- The refrigeration may be beneficially used for short times (less than one hour) above 60°C but less than 100°C.

This list is not intended to be complete, but only suggests some of the situations when automatic modes may not be best. Most of the time, the automatic functions are adequate and should be used.



# Chapter 9

## Controller Operation

Title	Page
Bath Temperature .....	9-3
Reset Cutout.....	9-3
Temperature Set-point .....	9-5
Programmable Set-points .....	9-5
Set-point Value.....	9-5
Set-point Vernier .....	9-6
Scan.....	9-6
Scan Control .....	9-6
Scan Rate .....	9-6
Temperature Scale Units.....	9-7
Ramp and Soak Program .....	9-7
Number of Program Set-points.....	9-7
Set-points.....	9-8
Program Soak Time.....	9-8
Program Function Mode.....	9-8
Program Control.....	9-9
Secondary Menu .....	9-9
Heater Power.....	9-9
Proportional Band.....	9-10
Cutout .....	9-12
Controller Configuration.....	9-13
Probe Parameters .....	9-13
R0 .....	9-13
ALPHA.....	9-13
Operating Parameters.....	9-13
Cutout Reset Mode.....	9-13
Cooling Mode.....	9-14
Hot Gas Bypass Mode .....	9-14
Serial Interface Parameters .....	9-15
Baud Rate .....	9-15
Sample Period.....	9-15
Duplex Mode .....	9-16
Linefeed.....	9-16
IEEE-488 Parameters.....	9-16
IEEE-488 Address.....	9-16
Transmission Termination.....	9-17
Calibration Parameters.....	9-17

CTO .....	9-17
CO and CG .....	9-17
H and L .....	9-17
HGbt .....	9-17

This chapter discusses in detail how to operate the bath temperature controller using the front control panel. Using the front panel key switches and LED display the user may monitor the bath temperature, set the temperature set-point in degrees C or F, monitor the heater output power, adjust the controller proportional band, set the cutout set-point, and program the probe calibration parameters, operating parameters, serial and IEEE-488 interface configuration, and controller calibration parameters. Operation is summarized in Figure 9-1.

## Bath Temperature

The digital LED display on the front panel allows direct viewing of the actual bath temperature. This temperature value is what is normally shown on the display. The units, C or F, of the temperature value are displayed at the right. For example,

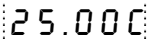
 Bath temperature in degrees Celsius

The temperature display function may be accessed from any other function by pressing the “EXIT” button.

## Reset Cutout

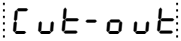
 Indicates cutout condition

The message continues to flash between the actual temperature and Cut-out until the temperature is reduced and the cutout is reset.

The cutout has two modes — automatic reset and manual reset. The mode determines how the cutout is reset which allows the bath to heat up again. When in automatic mode, the cutout will reset itself as soon as the temperature is lowered below the cutout set-point. With manual reset mode the cutout must be reset by the operator after the temperature falls below the set-point.

When the cutout is active and the cutout mode is set to manual (“reset”) then the display will flash “cutout” until the user resets the cutout. To access the reset cutout function press the “SET” button.

 Access cutout reset function

The display indicates the reset function.

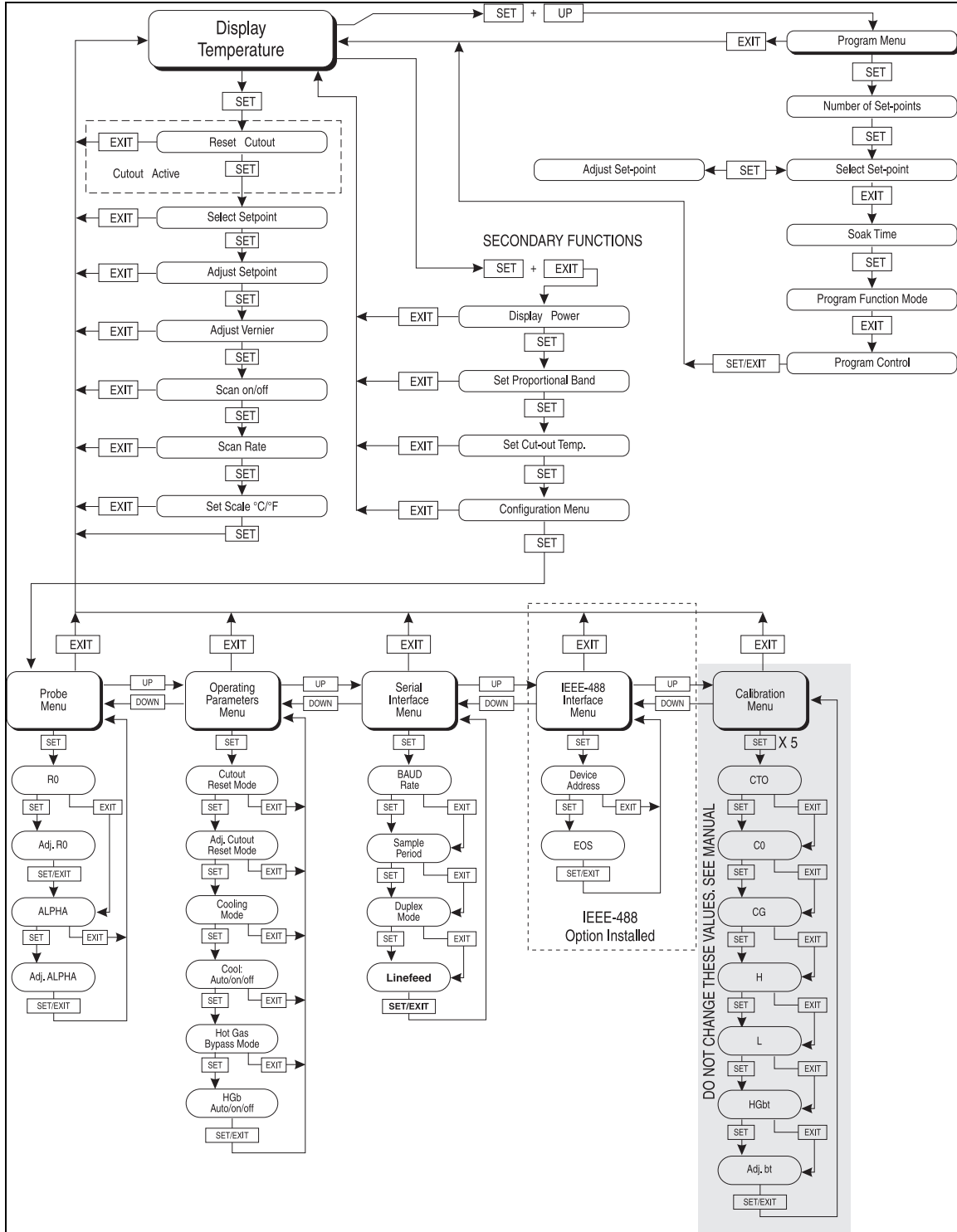

haz2005.eps

Figure 9-1. Controller Operation Flowchart

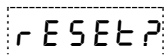

*Reset function*

Press "SET" once more to reset the cutout.



*Reset cutout*

This action switches the display to the set temperature function. To return to displaying the temperature display press the “EXIT” button. If the cutout is still in the over-temperature fault condition, the display continues to flash “cutout”. The bath temperature must drop a few degrees below the cutout set-point before the cutout can be reset.

## Temperature Set-point

The bath temperature can be set to any value within the range and with resolution as given in the specifications. The operator must know the temperature range of the particular fluid used in the bath and the bath should only be operated well below the upper temperature limit of the fluid. In addition, the cutout temperature should also be set below the upper limit of the fluid.

Setting the bath temperature involves three steps: 1) selecting the set-point memory, 2) adjusting the set-point value, and 3) adjusting the vernier, if desired.

### Programmable Set-points

The controller stores 8 set-point temperatures in memory. The set-points can be quickly recalled to conveniently set the bath to a previously programmed temperature set-point.

To set the bath temperature one must first select the set-point memory. This function is accessed from the temperature display function by pressing “SET”. The number of the set-point memory currently being used is shown at the left on the display followed by the current set-point value.

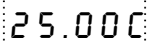
 Bath temperature in degrees Celsius

 Access set-point memory

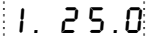
 1, 25.0°C currently used

To change the set-point memory press “UP” or “DOWN”.

 Increment memory

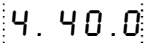
 New set-point memory 4, 40.0°C

Press “SET” to accept the new selection and access the set-point value.

 Accept selected set-point memory

### Set-point Value

After selecting the set-point memory and pressing “SET”, the set-point value may be adjusted in increments of 0.01° (C or F). The set-point value is displayed with the units, C or F, at the left.

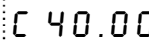
 Set-point 4 value in °C

If the set-point value does not need to be changed, press “EXIT” to resume displaying the bath temperature. Press “UP” or “DOWN” to adjust the set-point value.

 Increment display

 New set-point value

When the desired set-point value is reached, press “SET” to accept the new value and

access the set-point vernier. If “EXIT” is pressed, any changes made to the set-point are ignored.



*Accept new set-point value*

### Set-point Vernier

The user may want to adjust the set-point slightly to achieve a more precise bath temperature. The set-point vernier allows one to adjust the temperature below or above the set-point by a small amount with very high resolution. Each of the 8 stored set-points has an associated vernier setting. The set-point vernier can be set in increments of 0.00018°C. The vernier is accessed from the set-point by pressing “SET”. The vernier setting is displayed as a 6 digit number with five digits after the decimal point. This is a temperature offset in degrees of the selected units, C or F.

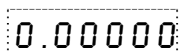

*Current vernier value in °C*

To adjust the vernier, press “UP” or “DOWN”. Unlike most functions the vernier setting has immediate effect as the vernier is adjusted. “SET” need not be pressed. This allows the bath temperature to be continually adjusted as it is displayed.



*Increment display*

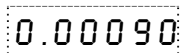

*New vernier setting*

Next press “EXIT” to return to the temperature display or “SET” to access the temperature scale units selection.



*Access scale units*

### Scan

The scan rate can be set and enabled so that when the set-point is changed the instrument heats or cools at a specified rate (degrees per minute) until it reaches the new set-point. With the scan disabled the instrument heats or cools at the maximum possible rate.

### Scan Control

The scan is controlled with the scan on/off function that appears in the main menu after the set-point function.

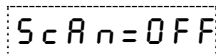

*Scan function off*

Press “UP” or “DOWN” to toggle the scan on or off.

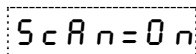

*Scan function on*

Press “SET” to accept the present setting and continue.



*Accept scan setting*

### IScan Rate

The next function in the main menu is the scan rate. The scan rate can be set from 0.001 to 5.0 °C/min. The maximum scan rate however is actually limited by the natural heating or cooling rate of the instrument. This is typically less than 2.5°C/min, especially when

cooling. The scan rate function appears in the main menu after the scan control function. The scan rate units are in degrees per minute, degrees C or F depending on the selected units.

 *Scan rate in °C/min*

Press “UP” or “DOWN” to change the scan rate.

 *New scan rate*

Press “SET” to accept the new scan rate and continue.

## Temperature Scale Units

The temperature scale units of the controller may be set by the user to degrees Celsius (°C) or Fahrenheit (°F). The units are used in displaying the bath temperature, set-point, vernier, proportional band, and cutout set-point. The temperature scale units selection is accessed after the vernier adjustment function by pressing “SET”. From the temperature display function access the units selection by pressing “SET” 4 times.

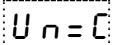
 *Scale units currently selected*

Press “UP” or “DOWN” to change the units.

 *Change units*

 *New units selected*

Press “SET” to accept the new selection and resume displaying the bath temperature.



 *Set the new units and resume temperature display*

## Ramp and Soak Program

The ramp and soak program feature allows the user to program a number of set-points and have the instrument automatically cycle between the temperatures, holding at each for a length of time. The user can select one of four different cycle functions.

The program parameter menu is accessed by pressing “SET” and then “UP”.

 *Well temperature*

 +  *Access program menu*

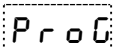
 *Program menu*

Press “SET” to enter the program menu

 *Enter program menu*

### Number of Program Set-points

The first parameter in the program menu is the number of set-points to cycle through. Up to 8 set-points can be used in a ramp and soak program. These set-points are independent from the programmable set-points described in Section Programmable Set-points.

**P n = 8**                      *Number of program set-points*

Use the “UP” or “DOWN” buttons to change the number from 2 to 8.

**P n = 3**                      *New number of program set-points*

Press “SET” to continue. Press “EXIT” to ignore any changes and to continue.

                      *Save new setting*

### **Set-points**

The next parameters are the program set-points.

**1 50.0**                      *First set-point*

Use the “UP” or “DOWN” buttons to select any of the set-points.

**3 30.0**                      *Third set-point*

Press “SET” to be able to change the set-point.

**C 30.0**                      *Set-point value*

Use “UP” and “DOWN” to change the set-point value.

**C 40.00**                      *New set-point value*

Press “SET” to save the new set-point value.

The other set-points can also be set in the same manner. Once the set-points are programmed as desired press “EXIT” to continue.

                      *Continue to next menu function*

### **Program Soak Time**

The next parameter in the program menu is the soak time. This is the time, in minutes, that each program set-point is maintained after settling before proceeding to the next set-point. The duration is counted from the time the temperature reaches the set-point.

**P t = 15**                      *Soak time in minutes*

Use the “UP” or “DOWN” buttons to change the time.

**P t = 5**                      *New soak time*

Press “SET” to continue.

                      *Save new setting*

### **Program Function Mode**

The next parameter is the program function or cycle mode. There are four possible modes which determine whether the program scans up (from set-point 1 to n) only or both up and down (from set-point n to 1), and also whether the program stops after one cycle or repeats the cycle indefinitely. Table 9-1 shows the action of each of the four program mode settings.



**Table 9-1. Program Mode Setting Actions**

Function	Action
1	up-stop
2	up-down-stop
3	up-repeat
4	up-down-repeat

**PF = 1**      *Program mode*

Use the “UP” or “DOWN” buttons to change the mode.

**PF = 4**      *New mode*

Press “SET” to continue.

      Enter program menu

### **Program Control**

The final parameter in the program menu is the control parameter. Three options are available for controlling the ramp and soak program. The options are to start the program from the beginning, ( **CO** ), continue the program from where it was when it was stopped ( **CONT** ), or stop the program ( **OFF** ).

**Pr = OFF**      *Program presently off*

Use the “UP” or “DOWN” buttons to change the status.

**Pr = CONT**      *Start cycle from beginning*

Press “SET” to activate the new program control command and return to the temperature display.

      *Activate new command*

### **Secondary Menu**

Functions, which are used less often, are accessed within the secondary menu. The secondary menu is accessed by pressing “SET” and “EXIT” simultaneously and then releasing. The first function in the secondary menu is the heater power display.

### **Heater Power**

The temperature controller controls the temperature of the bath by pulsing the heater on and off. The total power being applied to the heater is determined by the duty cycle or the ratio of heater on time to the pulse cycle time. This value may be estimated by watching the red/green control indicator light or read directly from the digital display. By knowing the amount of heating the user can tell if the bath is heating up to the set-point, cooling down, or controlling at a constant temperature. Monitoring the percent heater power lets the user know the stability of the bath temperature. With good control stability the percent heating power should not fluctuate more than ±1% within one minute.

The heater power display is accessed in the secondary menu. Press “SET” and “EXIT” simultaneously and release. The heater power is displayed as a percentage of full power.



Access heater power in secondary menu

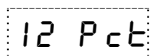

Heater power in percent

To exit out of the secondary menu press “EXIT”. To continue on to the proportional band setting function press “SET”.



Return to temperature display

## Proportional Band

In a proportional controller such as this, the heater output power is proportional to the bath temperature over a limited range of temperatures around the set-point. This range of temperature is called the proportional band. At the bottom of the proportional band the heater output is 100%. At the top of the proportional band the heater output is 0. Thus as the bath temperature rises the heater power is reduced, which consequently tends to lower the temperature back down. In this way the temperature is maintained at a fairly constant temperature.

The temperature stability of the bath depends on the width of the proportional band (see Figure 9-2). If the band is too wide, the bath temperature deviates excessively from the set-point due to varying external conditions. This is because the power output changes very little with temperature and the controller cannot respond very well to changing conditions or noise in the system. If the proportional band is too narrow, the bath temperature may swing back and forth because the controller overreacts to temperature variations. For best control stability the proportional band must be set for the optimum width.

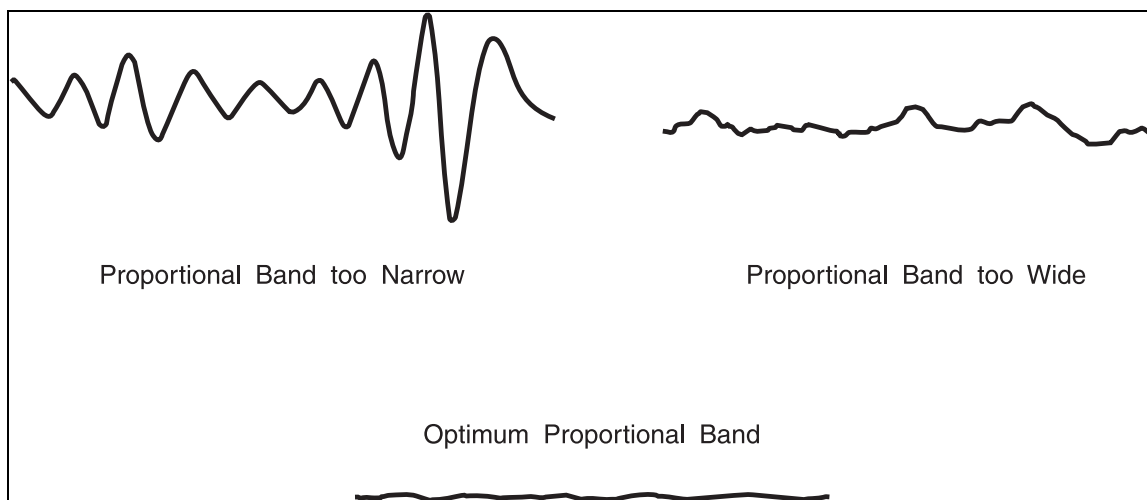

Figure 9-2. Bath Temperature Fluctuation At Various Proportional Band Settings

haz006.eps

The optimum proportional band width depends on several factors among which are fluid volume, fluid characteristics (viscosity, specific heat, thermal conductivity), heater power setting, operating temperature, and stirring. Thus the proportional band width may require adjustment for best bath stability when any of these conditions change. Of these, the most significant factors affecting the optimum proportional band width are heater power setting and fluid viscosity. The proportional band should be wider when the higher power setting is used so that the change in output power per change in temperature remains the same. The proportional band should also be wider when the fluid viscosity is higher



because of the increased response time.

The proportional band width is easily adjusted from the bath front panel. The width may be set to discrete values in degrees C or F depending on the selected units. The optimum proportional band width setting may be determined by monitoring the stability with a high resolution thermometer or with the controller percent output power display. Narrow the proportional band width to the point at which the bath temperature begins to oscillate and then increase the band width from this point to 3 or 4 times wider. Table 9-2 lists typical proportional band settings for optimum performance with a variety of fluids at selected temperatures.

**Table 9-2. Typical Proportional Band Settings for Various Fluids**

Fluid	Temperature	Proportional Band	Stability
Water	30°C	0.31°C	±0.003°C
Water	60°C	0.31°C	±0.003°C
Eth-Gly 50%	35°C	0.31°C	±0.005°C
Eth-Gly 50%	60°C	0.31°C	±0.005°C
Eth-Gly 50%	100°C	0.4°C	±0.010°C
Oil 200, 10cs	35°C	0.6°C	±0.004°C
Oil 200, 10cs	60°C	0.6°C	±0.004°C
Oil 200, 10cs	100°C	0.6°C	±0.004°C
Oil 710	200°C	0.4°C	±0.008°C

The proportional band adjustment may be accessed within the secondary menu. Press “SET” and “EXIT” to enter the secondary menu and show the heater power. Then press “SET” to access the proportional band.

 +       *Access heater power in secondary menu*

      *Heater power in percent*

      *Access proportional band*

      *Proportional band setting*

To change the proportional band press “UP” or “DOWN”.

      *Decrement display*

      *New proportional band setting*

To accept the new setting and access the cutout set-point press “SET”. Pressing “EXIT” will exit the secondary menu ignoring any changes just made to the proportional band value.

      *Accept the new proportional band setting*

## Cutout

As a protection against software or hardware fault, shorted heater triac, or user error, the bath is equipped with an adjustable heater cutout device that shuts off power to the heater if the bath temperature exceeds a set value. This protects the heater and bath materials from excessive temperatures and, most importantly, protects the bath fluids from being heated beyond the safe operating temperature preventing hazardous vaporization, breakdown, or ignition of the liquid. The cutout temperature is programmable by the operator from the front panel of the controller. It must always be set below the upper temperature limit of the fluid and no more than 10 degrees above the upper temperature limit of the bath.

If the cutout is activated because of excessive bath temperature, power to the heater is shut off and the bath cools. The display flashes “Cut-out” and the message will be sent over the communication ports. The bath cools until it reaches a few degrees below the cutout set-point temperature. At this point the action of the cutout is determined by the setting of the cutout mode parameter.

The cutout has two selectable modes — automatic reset or manual reset. If the mode is set to automatic, the cutout automatically resets itself when the bath temperature falls below the reset temperature allowing the bath to heat up again. If the mode is set to manual, the heater remains disabled until the user manually resets the cutout.

The cutout set-point may be accessed within the secondary menu. Press “SET” and “EXIT” to enter the secondary menu and show the heater power. Then press “SET” twice to access the cutout set-point.



*Access heater power in secondary menu*

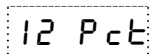

*Heater power in percent*



*Access proportional band*

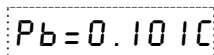

*Proportional band setting*



*Access cutout set-point*

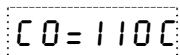

*Cutout set-point*

To change the cutout set-point press “UP” or “DOWN”.



*Decrement display*

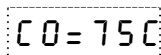

*New cutout set-point*

To accept the new cutout set-point press “SET”.



*Access cutout set-point*

The next function is the configuration menu. Press “EXIT” to resume displaying the bath temperature.

## Controller Configuration

The controller has a number of configuration and operating options and calibration parameters, which are programmable via the front panel. These are accessed from the secondary menu after the cutout set-point function by pressing “SET.” There are 5 sets of configuration parameters - probe parameters, operating parameters, serial interface parameters, IEEE-488 interface parameters, and controller calibration parameters. The menus are selected using the “UP” and “DOWN” keys and then pressing “SET”. Pressing “EXIT” in any secondary menu exits and returns to displaying the temperature (see Figure 9-1.).

### Probe Parameters

The probe menu is indicated by,

**P r O b E**      *Probe parameters menu*

Press “SET” to enter the menu. The probe parameters menu contains the parameters, R0 and ALPHA, which characterize the resistance-temperature relationship of the platinum control probe. These parameters may be adjusted to improve the accuracy of the bath. This procedure is explained in detail in Chapter 11, Calibration Procedure.

The probe parameters are accessed by pressing “SET” after the name of the parameter is displayed. The value of the parameter may be changed using the “UP” and “DOWN” buttons. After the desired value is reached press “SET” to set the parameter to the new value. Press “EXIT” to skip the parameter ignoring any changes that have been made.

#### R0

This probe parameter refers to the resistance of the control probe at 0°C. Normally this is set for 100.000 ohms.

#### ALPHA

This probe parameter refers to the average sensitivity of the probe between 0 and 100°C. Normally this is set for 0.00385°C<sup>-1</sup>.

### Operating Parameters

The operating parameters menu is accessed by pressing “UP” when the probe menu is displayed.

The operating parameters menu is indicated by,

**P A r**      *Operating parameters menu*

Press “UP” to enter the menu. The operating parameters menu contains the cutout reset mode parameter, cooling mode, and hot gas bypass mode.

#### Cutout Reset Mode

The cutout reset mode determines whether the cutout resets automatically when the bath temperature drops to a safe value or must be manually reset by the operator.

The parameter is indicated by,

**C t o r S t**      *Cutout reset mode parameter*

Press “SET” to access the parameter setting. The cutout is set at the factory for manual mode.

**C t o = A u t o**      *Cutout set for automatic reset*

To change to manual reset mode press “UP” and then “SET”.

**Ct o = r St**      *Cutout set for manual reset*

### Cooling Mode

The cooling mode determines whether refrigeration is in Auto mode, On, or Off. Normally the cooling mode is set to Auto mode. In the Auto mode, the refrigeration is ‘On’ below approximately 60°C. Note: If the fluid is cooling from above 60°C, the refrigeration turns on at approximately 59°C. If the fluid is heating from below 60°C, the refrigeration shuts off at 60°C. If the set point is more than 5°C higher than the current bath temperature, the refrigeration will automatically shut off until needed to maintain the temperature selected. There may be times when Auto mode is undesirable. In that case, the refrigeration may be set to On or Off. When the refrigeration is set to On or Off, the refrigeration is on or off for all temperatures.

#### **⚠ CAUTION**

**The refrigeration may be damaged or the lifetime shortened if used above 60°C for more than one hour.**

The parameter is indicated by,

**Co o L = r St**      *Cooling mode parameter*

Press “SET” to access the parameter setting.

**Auto**      *Cooling mode set for automatic*

To change to On or Off mode, press “DOWN” until the desired mode appears and then press “SET”.

**On**      *Cooling mode set to on*

**OFF**      *Cooling mode set to off*

Individual steps may be skipped by pressing “EXIT”

### Hot Gas Bypass Mode

The hot gas bypass (HGb) system is a method of reducing cooling or refrigeration capacity. It is normally used above approximately 0°C. Reducing cooling capacity helps improve temperature stability in the bath and reduces energy consumption. The HGb system is normally in the automatic mode which switches on (reducing capacity) when at set-points above 0°C. When the bath is scanning to lower temperatures (greater than 2°C below the starting temperature) the HGb turns off for full cooling capacity for all temperatures below the maximum refrigeration limit even above 0°C.

There are three HGb modes; Auto, On, or Off. Normally HGb mode is set to Auto mode. If for some reason the automatic mode is undesirable, the HGb mode can be set to always On or Off.

The parameter is indicated by,

**HGb**      *HGb mode parameter*

Press “SET” to access the parameter setting.

**Auto**      *HGb mode set for automatic*

To change to On or Off mode, press “DOWN” until the desired mode appears and then press “SET”.

**0n** *HGb mode set to on*

**OFF** *HGb mode set to off*

## Serial Interface Parameters

The serial interface menu is accessed by pressing “UP” from the operating parameters menu.

The serial RS-232 interface parameters menu is indicated by,

**SERIAL** *Serial RS-232 interface parameters menu*

The serial interface parameters menu contains parameters which determine the operation of the serial interface. The parameters in the menu are—baud rate, sample period, duplex mode, and linefeed.

### Baud Rate

The baud rate is the first parameter in the menu. The baud rate setting determines the serial communications transmission rate.

The baud rate parameter is indicated by,

**BAUD** *Serial baud rate parameter*

Press “SET” to choose to set the baud rate. The current baud rate value will then be displayed.

**1200b** *Current baud rate*

The baud rate of the bath serial communications may be programmed to 300, 600, 1200, or 2400 baud. Use “UP” or “DOWN” to change the baud rate value.

**2400b** *New baud rate*

Press “SET” to set the baud rate to the new value or “EXIT” to abort the operation and skip to the next parameter in the menu.

### Sample Period

The sample period is the next parameter in the serial interface parameter menu. The sample period is the time period in seconds between temperature measurements transmitted from the serial interface. If the sample rate is set to 5, the bath transmits the current measurement over the serial interface approximately every five seconds. The automatic sampling is disabled with a sample period of 0. The sample period is indicated by,

**SAMPLE** *Serial sample period parameter*

Press “SET” to choose to set the sample period. The current sample period value will be displayed.

**SAMPLE** *Current sample period (seconds)*

Adjust the value with “UP” or “DOWN” and then use “SET” to set the sample rate to the displayed value.

**SAMPLE** *New sample period*

## Duplex Mode

The next parameter is the duplex mode. The duplex mode may be set to full duplex or half duplex. With full duplex, any commands received by the bath via the serial interface are executed and immediately echoed or transmitted back to the device of origin. With half duplex, the commands are executed but not echoed. The duplex mode parameter is indicated by,

`dUPL` *Serial duplex mode parameter*

Press “SET” to access the mode setting.

`dUP=FULL` *Current duplex mode setting*

The mode may be changed using “UP” or “DOWN” and pressing “SET”.

`dUP=HALF` *New duplex mode setting*

## Linefeed

The final parameter in the serial interface menu is the linefeed mode. This parameter enables (on) or disables (off) transmission of a linefeed character (LF, ASCII 10) after transmission of any carriage-return. The linefeed parameter is indicated by,

`LF` *Serial linefeed parameter*

Press “SET” to access the linefeed parameter.

`LF=ON` *Current linefeed setting*

The mode may be changed using “UP” or “DOWN” and pressing “SET”.

`LF=OFF` *New linefeed setting*

## IEEE-488 Parameters

Baths may optionally be fitted with an IEEE-488 GPIB interface. In this case the user may set the interface address and the transmission termination character within the IEEE-488 parameter menu. This menu does not appear on baths not fitted with the interface. The menu is accessed by pressing “UP” from the serial parameter menu. The menu is indicated by,

`IEEE` *IEEE-488 parameters menu*

Press “SET” to enter the menu.

## IEEE-488 Address

The IEEE-488 interface must be configured to use the same address as the external communicating device. The address is indicated by,

`ADDR55` *IEEE-488 interface address*

Press “SET” to access the address setting.

`ADD=22` *Current IEEE-488 interface address*

Adjust the value with “UP” or “DOWN” and then use “SET” to set the address to the displayed value.

`ADD=15` *New IEEE-488 interface address*



### Transmission Termination

The transmission termination character can be set to carriage return only, linefeed only, or carriage return and linefeed. Regardless of the option selected, the instrument will interpret either a carriage return or a linefeed as a command termination during reception.

The termination parameter is indicated with,

**E O S** *IEEE-488 termination*

Press “SET” to access the termination setting.

**E = C r** *Present IEEE-488 termination*

Use “UP” or “DOWN” to change the selection.

**E = L F** *New termination selection*

Use “SET” to save the new selection.

### Calibration Parameters

The operator of the bath controller has access to a number of the instrument calibration constants namely CTO, C0, CG, H, L, and HGbt. These values are set at the factory and must not be altered. The correct values are important to the accuracy and proper and safe operation of the bath. These parameters should not be adjusted. In the event the controller’s memory fails, the user may restore these values to the factory settings. A list of these constants and their settings are supplied to the user on the Report of Test with the manual.

#### **⚠ CAUTION**

**DO NOT change the values of the instrument calibration constants from the factory set values. The correct setting of these parameters is important to the safety and proper operation of the instrument.**

The calibration parameters menu is indicated by,

**C R L** *Calibration parameters menu*

Press “SET” five times to enter the menu.

#### CTO

Parameter CTO sets the calibration of the over-temperature cutout. This is not adjustable by software but is adjusted with an internal potentiometer. This parameter is set at the factory.

#### CO and CG

These parameters calibrate the accuracy of the instrument set-point. These are programmed at the factory. Do not alter the value of these parameters. If the user desires to calibrate the bath for improved accuracy, adjust R0 and ALPHA according to the procedure given in Chapter 11, Calibration Procedure.

#### H and L

These parameters set the upper and lower set-point limits of the bath.

#### *Note*

*A high limit (H) setting below the flash point of the fluid in the bath is highly recommended.*

#### HGbt

This parameter is the temperature where the hot gas bypass activates. This parameter is factory set. To insure the bath's best performance without damaging its compressor, **DO NOT** alter the value of this parameter.

# Chapter 10

## *Digital Communication Interface*

<b>Title</b>	<b>Page</b>
Serial Communications .....	10-3
Wiring .....	10-3
Setup .....	10-4
Baud Rate .....	10-4
Sample Period .....	10-4
Duplex Mode .....	10-4
Linefeed .....	10-4
Serial Operation .....	10-4
IEEE-488 Communication (optional) .....	10-4
Setup .....	10-5
IEEE-488 Address .....	10-5
Transmission Termination .....	10-5
IEEE-488 Operation .....	10-5
Interface Commands .....	10-5
Cooling Control .....	10-5



The 7341 bath is capable of communicating with and being controlled by other equipment through the digital interface. Two types of digital interface are available - the RS-232 serial interface which is standard and the IEEE-488 GPIB interface which is optional.

With a digital interface the bath may be connected to a computer or other equipment. This allows the user to set the bath temperature, monitor the temperature, and access any of the other controller functions, all using remote communications equipment. In addition the cooling may be controlled using the interface. To control the cooling with the interface the cooling power switch must be ON.

## Serial Communications

The RS-232 serial interface allows serial digital communications over fairly long distances (15.24 meters). With the serial interface the user may access any of the functions, parameters and settings discussed in Chapter 9, Controller Operation, with the exception of the baud rate setting. The serial interface operates with eight data bits, one stop bit, and no parity.

### Wiring

The serial communications cable attaches to the bath through the DB-9 connector on the back of the instrument. Figure 10-1 shows the pin-out of this connector and the suggested cable wiring. To eliminate noise, the serial cable should be shielded with low resistance between the connector (DB-9) and the shield.

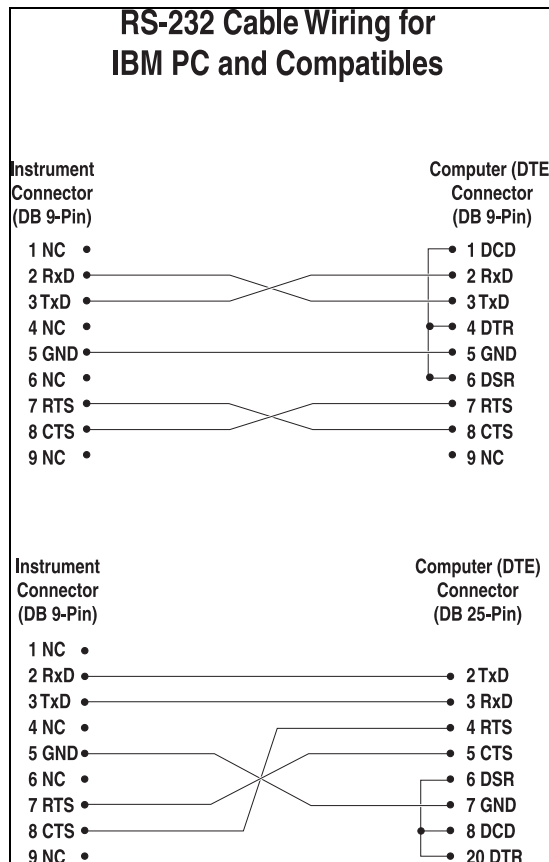

Figure 10-1. Serial Communications Cable Wiring

haz007.eps

## Setup

Before operation the serial interface of the bath must first be set up by programming the baud rate and other configuration parameters. These parameters are programmed within the serial interface menu.

To enter the serial parameter programming menu, press “EXIT” while holding down “SET”, then release both buttons to enter the secondary menu. Press “SET” repeatedly until the display reads “P R O B E”. This is the menu selection. Press “UP” repeatedly until the serial interface menu is indicated with “S E R I A L”. Finally press “SET” to enter the serial parameter menu. In the serial interface parameters menu are the baud rate, the sample rate, the duplex mode, and the linefeed parameter.

## Baud Rate

The baud rate is the first parameter in the menu. The display prompts with the baud rate parameter by showing “B A U D”. Press “SET” to choose to set the baud rate. The current baud rate value is displayed. The baud rate of the bath may be programmed to 300, 600, 1200, or 2400 baud. The baud rate is pre-programmed to 2400 baud. Use “UP” or “DOWN” to change the baud rate value. Press “SET” to set the baud to the new value or “EXIT” to abort the operation and skip to the next parameter in the menu.

## Sample Period

The sample period is the next parameter in the menu and prompted with “S A M P L E”. The sample period is the time period, in seconds, between temperature measurements transmitted from the serial interface. If the sample period is set to 5, the bath transmits the current measurement over the serial interface approximately every five seconds. The automatic sampling is disabled with a sample period of 0. Press “SET” to choose to set the sample period. Adjust the period with “UP” or “DOWN”. Press “SET” to set the sample period to the new value or “EXIT” to abort and skip to the next parameter.

## Duplex Mode

The next parameter is the duplex mode indicated with “D U P L”. The duplex mode may be set to half duplex (“H A L F”) or full duplex (“F U L L”). With full duplex, any commands received by the bath via the serial interface are executed and immediately echoed or transmitted back to the device of origin. With half duplex, the commands are executed but not echoed. The default setting is full duplex. The mode may be changed using “UP” or “DOWN”. Press “SET” to save the new setting or “EXIT” to abort and skip to the next parameter.

## Linefeed

The final parameter in the serial interface menu is the linefeed mode. This parameter enables (“O N”) or disables (“O F F”) transmission of a linefeed character (LF, ASCII 10) after transmission of any carriage-return. The default setting is with linefeed on. The mode may be changed using “UP” or “DOWN”. Press “SET” to set the sample period to the new value or “EXIT” to abort and skip to the next parameter.

## Serial Operation

Once the cable has been attached and the interface set up properly the controller will immediately begin transmitting temperature readings at the programmed rate. The set-point and other commands may be sent to the bath via the serial interface to set the bath and view or program the various parameters. The interface commands are discussed in Interface Commands.

## IEEE-488 Communication (optional)

The IEEE-488 interface is available as an option. Baths supplied with this option may be connected to a GPIB type communication bus, which allows many instruments to be connected and controlled simultaneously. To eliminate noise, the GPIB cable should be

shielded.

### **Setup**

To use the IEEE-488 interface connect an IEEE-488 standard cable to the back of the bath, set the device address, and set the transmission termination character.

To enter the IEEE-488 parameter menu, press “EXIT” while holding down “SET”, then release both buttons to enter the secondary menu. Press “SET” repeatedly until the display reaches “P R O B E”. Press “UP” repeatedly until the IEEE-488 interface menu is indicated with “I E E E”. Press “SET” to enter the IEEE-488 parameter menu.

### **IEEE-488 Address**

The IEEE-488 address is indicated with “A D D R E S S”. Press “SET” to program the address. The default address is 22. Change the device address of the bath if necessary to match the address used by the communication equipment by pressing “UP” or “DOWN”. Press “SET” to save the new setting or “EXIT” to abort and skip to the next parameter.

### **Transmission Termination**

The IEEE-488 transmission termination is indicated with “E O S”. Press “SET” to access the termination character. The present setting is displayed. Press “UP” or “DOWN” to change the setting. Press “SET” to save the new setting or “EXIT” to abort and skip to the next parameter.

### **IEEE-488 Operation**

Commands may now be sent via the IEEE-488 interface to read or set the temperature or access other controller functions. All commands are ASCII character strings and are terminated with a carriage-return (CR, ASCII 13). Interface commands are listed below.

## **Interface Commands**

The various commands for accessing the bath controller functions via the digital interfaces are listed in this section (see Table 10-1). These commands are used with both the RS-232 serial interface and the IEEE-488 GPIB interface. In either case the commands are terminated with a carriage-return character. The interface makes no distinction between upper and lower case letters, hence either may be used. Commands may be abbreviated to the minimum number of letters, which determines a unique command. A command may be used to either set a parameter or display a parameter depending on whether or not a value is sent with the command following a “=” character. For example an “s” <cr> returns the current set-point and an “s=50.00” <cr> sets the set-point to 50.00 degrees.

In the list of commands, characters or data within brackets, “[” and “]”, are optional for the command. A slash, “/”, denotes alternate characters or data. Numeric data, denoted by “n”, may be entered in decimal or exponential notation. Characters are shown in lower case although upper case may be used. Spaces may be added within command strings and will simply be ignored. Backspace (BS, ASCII 8) may be used to erase the previous character. A terminating CR is implied with all commands.

## **Cooling Control**

The 7341 bath has a fully automated refrigeration control system when the cooling power switch on the front panel is activated. Under normal conditions, the refrigeration is on at any temperature below approximately 60°C (see Refrigeration in Chapter 8). When the bath is controlling at temperatures between 0°C and 60°C, the refrigeration is in the hot gas bypass or reduced cooling mode. Below 0°C the refrigeration is in the high cooling mode and the hot gas bypass is turned off automatically. When the bath is cooling from one temperature to another below 60°C, cooling is at maximum until the bath is within 1 degree C of the set-point. These conditions are the default conditions but may be altered

in the following ways.

- The cooling (refrigeration) may be set to operate in the auto, on, or off modes. See Cooling Mode in Chapter 9.
- The hot gas bypass or reduced cooling mode may also be set to on, off, or auto.

The “auto” modes allow the bath to operate automatically in the manner described above. The cooling “on” function eliminates this auto feature and the refrigeration is on at all times unless the front panel switch is turned off or until some other menu selection is made. The hot gas bypass mode selection works the same way. The “auto” function is the default and active until off or on is selected. “On” means it is always on with no automatic selection and “off” is always off (or cooling always on maximum). It may desirable for different reasons to eliminate the automatic functioning; therefore, these selections are made available either through the front panel or through the digital communications interface.

**Table 10-1. Interface Command Summary**

Command Description	Command Format	Command Example	Returned	Returned Example	Acceptable Values
<b>Display Temperature</b>					
Read current set-point	s[etpoint]	s	set: 9999.99 {C or F}	set: 150.00 C	
Set current set-point to n	s[etpoint]=n t[emperature]=n	s=150 t=150			Instrument Range -40 to 150°C
Read vernier	v[ernier]	v	v: 9.99999	v: 0.00000	
Set vernier to n	v[ernier]=n	v=.00018			Depends on Configuration
Read scan function	sc[an]	sc	scan: {ON or OFF}	scan: ON	
<b>Set scan function:</b>	<b>sc[an]=on/of[f]</b>				
Turn scan function on	sc[an]=on	sc=on			
Turn scan function off	sc[an]=of[f]	sc=of			
Read scan rate	sr[ate]	sr	srat: 9.999 {C or F}/min	srat: 0.010 C/min	
Set scan rate to n degrees per minute	sr[ate]=n	sr=5			0.001 to 5.000°C/min 0.001 to 9.000°F/min
Read temperature	t[emperature]	t	t: 9999.99 {C or F}	t: 55.69 C	
Read temperature units	u[nits]	u	u: x	u: C	
<b>Set temperature units:</b>	<b>u[nits]=c/f</b>				
Set temperature units to Celsius	u[nits]=c	u=c			
Set temperature units to Fahrenheit	u[nits]=f	u=f			



Table 10-1. Interface Command Summary (cont.)

Command Description	Command Format	Command Example	Returned	Returned Example	Acceptable Values
<b>Ramp and Soak Menu</b>					
Read number of programmable set-points	pn	pn	pn: 9	pn: 2	
Set number of programmable set-points to n	pn=n	pn=4			
Read programmable set-point number n	psn	ps3	psn: 9999.99 {C or F}	ps1: 50.00 C	
Set programmable set-point number n to n	psn=n	ps3=50			1 to 8, Instrument Range -40 to 150°C
Read program set-point soak time	pt	pt	ti: 999	ti: 5	
Set program set-point soak time to n minutes	pt=n	pt=5			0 to 500
Read program control mode	pc	pc	prog: {OFF or ON}	prog: OFF	
<b>Set program control mode:</b>	<b>pc=g[o]/s[top]/c[ont]</b>				GO or STOP or CONT
Start program	pc=g[o]	pc=g			
Stop program	pc=s[top]	pc=s			
Continue program	pc=c[ont]	pc=c			
Read program function	pf	pf	pf: 9	pf: 3	
Set program function to n	pf=n	pf=2			1 to 4
<b>Secondary Menu</b>					
Read proportional band setting	pr[op-band]	pr	pr: 9.999	pr: 0.326	
Set proportional band to n	pr[op-band]=n	pr=0.326			
Read cutout setting	c[utout]	c	cu: 999 {x},{xxx}	cu: 160 C, in	
<b>Set cutout setting:</b>	<b>c[utout]=n/r[eset]</b>				
Set cutout to n degrees	c[utout]=n	c=160			Temperature Range
Reset cutout now	c[utout]=r[eset]	c=r			
Read heater power (duty cycle)	po[wer]	po	po: 9999	po: 1	

Table 10-1. Interface Command Summary (cont.)

Command Description	Command Format	Command Example	Returned	Returned Example	Acceptable Values
<b>Configuration Menu</b>					
Probe Menu					
Read R0 calibration parameter	r[0]	r	r0: 999.999	r0: 100.578	
Set R0 calibration parameter to n	r[0]=n	r=100.324			98.0 to 104.999
Read ALPHA calibration parameter	al[pha]	al	al: 9.9999999	al: 0.0038573	
Set ALPHA calibration parameter to n	al[pha]=n	al=0.0038433			.00370 to .0039999
Operating Parameters Menu					
Read cutout mode	cm[ode]	cm	cm: {xxxx}	cm: auto	
<b>Set cutout mode:</b>	<b>cm[ode]=r[eset]/a[uto]</b>				
Set cutout to be reset manually-	cm[ode]=r[eset]	cm=r			
Set cutout to be reset automatically	cm[ode]=a[uto]	cm=a			
<b>Serial Interface Menu</b>					
Read serial sample setting	sa[mple]	sa	sa: 9999	sa: 1	
Set serial sampling setting to n seconds	sa[mple]=n	sa=0			0 to 4000
Set serial duplex mode:	<b>du[plex]=f[ull]/h[alf]</b>				FULL or HALF
Set serial duplex mode to full	du[plex]=f[ull]	du=f			
Set serial duplex mode to half	du[plex]=h[alf]	du=h			
Set serial linefeed mode:	<b>lf[eed]=on/of[f]</b>				
Set serial linefeed mode to on	lf[eed]=on	lf=on			
Set serial linefeed mode to off	lf[eed]=of[f]	lf=of			
<b>Calibration Menu</b>					
Read C0 calibration parameter	*c0	*c0	c0: 9.9999	c0: 0.0002	
Set C0 calibration parameter to n	*c0=n	*c0=0			Unlimited
Read CG calibration parameter	*cg	*cg	cg: 999.99	cg: 406.25	

Set CG calibration parameter to n	*cg=n	*cg=406.25			Unlimited
-----------------------------------	-------	------------	--	--	-----------

**Table 10-1. Interface Command Summary (cont.)**

Command Description	Command Format	Command Example	Returned	Returned Example	Acceptable Values
Read Cool mode	co[o]	co	co:xxx	co: auto	
Set Cool mode:	<b>co[o]=of[f]/on/au[to]</b>				On, Off, Auto
Set Cool mode to Off	co[o]=of[f]	co=of			
Set Cool mode to On	co[o]=on	co=on			
Set Cool mode to Auto	co[o]=au[to]	co=au			
Read HGB mode	hg[b]	hg	hgb:xxx	hgb: auto	
Set HGB mode:	<b>hg[b]=of[f]/on/au[to]</b>				On, Off, Auto
Set HGB mode to Off	hg[b]=of[f]	hg=of			
Set HGB mode to On	hg[b]=on	hg=on			
Set HGB mode to Auto	hg[b]=a[uto]	hg=au			
Read low set-point limit value	*tl[ow]	*tl	tl: 999	tl: -40	
Set low set-point limit to n	*tl[ow]=n	*tl=-40			-60 to 20
Read high set-point limit value	*th[igh]	*th	th: 999	th: 150	
Set high set-point limit to n	*th[igh]=n	*th=150			-150 to 30
<b>Miscellaneous (not on menus)</b>					
Read all extended parameters	all	all	list of extended parameters		
Read firmware version number	*ver[sion]	*ver	ver.9999,9.99	ver.7341,1.00	
Read all operating parameters	*all	*all	list of operating parameters		
Read structure of all commands	h[elp]	h	list of commands		
Legend:	[] Optional Command data {} Returns either information n Numeric data supplied by user 9 Numeric data returned to user x Character data returned to user				
Note:	When DUPLEX is set to FULL and a command is sent to READ, the command is returned followed by a carriage return and linefeed. Then the value is returned as indicated in the RETURNED column.				



# **Chapter 11**

## **Calibration Procedure**

<b>Title</b>	<b>Page</b>
Calibration Points .....	11-3
Measuring the Set-point Error .....	11-3
Computing R0 and ALPHA.....	11-3
Calibration Example .....	11-4



In some instances the user may want to calibrate the bath to improve the temperature set-point accuracy. Calibration is done by adjusting the controller probe calibration constants R0 and ALPHA so that the temperature of the bath as measured with a standard thermometer agrees more closely with the bath set-point. The thermometer used must be able to measure the bath fluid temperature with higher accuracy than the desired accuracy of the bath. By using a good thermometer and carefully following procedure the bath can be calibrated to an accuracy of better than 0.2°C over a range of 100 degrees.

## Calibration Points

In calibrating the bath R0 and ALPHA are adjusted to minimize the set-point error at each of two different bath temperatures. Any two reasonably separated bath temperatures may be used for the calibration however best results will be obtained when using bath temperatures which are just within the most useful operating range of the bath. *The further apart the calibration temperatures, the greater the calibrated temperature range and the calibration error.* If, for instance, 0°C and 100°C are chosen as the calibration temperatures, the bath may achieve an accuracy of ±0.3°C over the range -10 to 110°C. Choosing 30°C and 70°C may allow the bath to have a better accuracy of ±0.1°C over the range 25 to 75°C, but, outside that range the accuracy may be only ±0.5°C.

## Measuring the Set-point Error

The first step in the calibration procedure is to measure the temperature errors (including sign) at the two calibration temperatures. First set the bath to the lower set-point,  $t_L$ . Wait for the bath to reach the set-point and allow 15 minutes to stabilize at that temperature. Check the bath stability with the thermometer. When both the bath and the thermometer have stabilized, measure the actual bath temperature and compute the temperature error,  $err_L$  (the actual bath temperature minus the set-point temperature). For example, set the bath to 0°C. The bath reaches a measured temperature of -0.3°C giving an error of -0.3°C.

Next, set the bath for the upper set-point,  $t_H$ , and after stabilizing, measure the bath temperature and compute the error  $err_H$ . For example, set the bath to 100°C, the thermometer measures 100.1°C giving an error of +0.1°C.

## Computing R0 and ALPHA

Before computing the new values for R0 and ALPHA the current values must be known. The values may be found by either accessing the probe calibration menu from the controller panel or by inquiring through the digital interface. The user should keep a record of these values in case they may need to be restored in the future. The new values R0' and ALPHA' are computed by entering the old values for R0 and ALPHA, the calibration temperature set-points  $t_L$  and  $t_H$ , and the temperature errors  $err_L$  and  $err_H$  into the following equations,

$$R_0' = \left[ \frac{err_H t_L - err_L t_H}{t_H - t_L} ALPHA + 1 \right] R_0$$

$$ALPHA' = \left[ \frac{(1 + ALPHA t_H)err_L - (1 + ALPHA t_L)err_H}{t_H - t_L} + 1 \right] ALPHA$$

If R0 and ALPHA were previously set for 100.000 and 0.0038500 respectively and the data for  $t_L$ ,  $t_H$ ,  $err_L$ , and  $err_H$  were as given above then the new values R0' and ALPHA' would be computed as 110.116 and 0.0038302 respectively. Program the new values R0 and ALPHA into the controller. Check the calibration by setting the temperature to  $t_L$  and

$t_H$  and measuring the errors again. If desired, the calibration procedure may be repeated again to further improve the accuracy.

### Calibration Example

The bath is to be used between 25°C and 75°C and it is desired to calibrate the bath as accurately as possible for operation within this range. The current values for R0 and ALPHA are 100.000 and 0.0038500 respectively. The calibration points are chosen to be 30.00 and 80.00°C. The measured bath temperatures are 29.843 and 79.914°C respectively. Refer to Figure 11-1 for applying equations to the example data and computing the new probe constants.

R0 = 100.000  
 ALPHA = 0.0038500  
 $t_L = 30.00^\circ\text{C}$   
 measured t = 29.843°C  
 $t_H = 80.00^\circ\text{C}$   
 measured t = 79.914°C

Compute errors,  
 $\text{err}_L = 29.843 - 30.00^\circ\text{C} = -0.157^\circ\text{C}$   
 $\text{err}_H = 79.914 - 80.00^\circ\text{C} = -0.086^\circ\text{C}$

Compute R0',

$$R_0' = \left[ \frac{(-0.086) \times 30.0 - (-0.157) \times 80.0}{80.0 - 30.0} 0.00385 + 1 \right] 100.000 = 100.077$$

Compute ALPHA',

$$ALPHA' = \left[ \frac{(1 + 0.00385 \times 80.0)(-0.157) - (1 + 0.00385 \times 30.0)(-0.086)}{80.0 - 30.0} + 1 \right] 0.00385 = 0.0038416$$

Figure 11-1. Calibration Example

haz008.eps



# Chapter 12

## Maintenance

The calibration instrument has been designed with the utmost care. Ease of operation and simplicity of maintenance have been a central theme in the product development. Therefore, with proper care the instrument should require very little maintenance. Avoid operating the instrument in dirty or dusty environments.

- A battery is used to maintain operating parameters in the unit. All operating parameters, including calibration parameters should be checked on a regular basis to insure accuracy and proper operation of the instrument. See the troubleshooting section for the procedure on checking the status of the battery.
- If the outside of the bath becomes soiled, it may be wiped clean with a damp cloth and mild detergent. Do not use harsh chemicals on the surface, which may damage the paint.
- Periodically check the fluid level in the bath to ensure that the level has not dropped. If the fluid level is too low, the stability may be affected. Changes in fluid level are dependent upon several factors specific to the conditions in which the equipment is used. A schedule cannot be outlined to meet each set of conditions. Therefore, the bath should be checked weekly and adjustments made as required.

### Warning

**Before servicing the instrument, disconnect the power mains.**

- Periodically remove the top cover of the bath and wipe out oil around the outside of the gasket. In order to do this, remove the four screws on the top surface and the two screws at the rear of the bath. Lift the cover just far enough to wipe out the collected oil.
- Heat transfer medium lifetime is dependent upon the type of medium and the conditions of use. The fluid should be checked at least every month for the first year and regularly thereafter. This fluid check provides a baseline for knowledge of bath operation with clean, usable fluid. Once some fluids have become compromised, the break down can occur rapidly. Particular attention should be paid to the viscosity of the fluid. A significant change in the viscosity can indicate that the fluid is contaminated, being used outside of its temperature limits, contains ice particles, or is close to a chemical breakdown. Once data has been gathered, a specific maintenance schedule can be outlined for the instrument. Refer to Chapter 8, General Operation, for more information about the different types of fluids used in calibration baths.
- Depending on the cleanliness of the environment, a schedule should be set for cleaning the condensing coil fins. Use low pressure compressed air directed at a downward angle to remove lint and dust build-up on the condensing fin coils. The schedule should be set dependent upon the laboratory environment to ensure that dust does not build up on the fins hampering the efficiency of the bath, i.e. monthly, quarterly.
- If a hazardous material is spilt on or inside the equipment, the user is responsible for taking the appropriate decontamination steps as outlined by the national safety council with respect to the material. MSDS sheets applicable to all fluids used in the

baths should be kept in close proximity to the instrument.

- If the mains supply cord becomes damaged, replace it with a cord of the appropriate gauge wire for the current of the bath. If there are any questions, call an Authorized Service Center (see Authorized Service Centers in Chapter 1) for more information.
- Before using any cleaning or decontamination method except those recommended by Fluke, users should check with an Authorized Service Center (see Authorized Service Centers in Chapter 1) to be sure that the proposed method will not damage the equipment.
- If the instrument is used in a manner not in accordance with the equipment design, the operation of the bath may be impaired or safety hazards may arise.
- The over-temperature cutout should be checked every 6 months to see that it is working properly. In order to check the user selected cutout, follow the controller directions in Reset Cutout in Chapter 9, for setting the cutout. Both the manual and the auto reset option of the cutout should be checked. Set the bath temperature higher than the cutout. Check to see if the display flashes cutout and if the temperature is decreasing.

*Note*

*When checking the over-temperature cutout, be sure that the temperature limits of the bath fluid are not exceeded. Exceeding the temperature limits of the bath fluid could cause harm to the operator, lab, and instrument.*

- When using silicon oil, the bath will require periodic maintenance. The silicon oil will condense on the bath during normal operation due to the outgassing of the oil. How often and how long the bath is operated at higher temperatures determines how often the maintenance will have to be performed. Simply wipe down the oily areas of the bath with a mild degreaser such as 409®. Do not spray the degreaser directly on the bath. Spray the degreaser on a cloth and wipe the bath down with the cloth. Repeat the process as often as necessary to keep the oil from collecting on the bath. If oil is allowed to collect on the bath, it may run into the bath and collect on the interior of the bath causing internal damage that may affect the lifetime of the instrument.

# **Chapter 13**

## **Troubleshooting**

<b>Title</b>	<b>Page</b>
Troubleshooting .....	13-3
Comments .....	13-6
EMC Directive.....	13-6
Immunity Testing .....	13-6
Emission Testing.....	13-6
Low Voltage Directive (Safety) .....	13-6



This section contains information on troubleshooting, CE Comments, and a wiring diagram. This information pertains to a number of bath models and certain specifics may not pertain to your model.

## Troubleshooting

In the event that the instrument appears to function abnormally, this section may help to find and solve the problem. Several possible problem conditions are described along with likely causes and solutions. If a problem arises, please read this section carefully and attempt to understand and solve the problem. If the probe seems faulty or the problem cannot otherwise be solved, contact an Authorized Service Center (see Authorized Service Centers in Chapter 1) for assistance. Be sure to have the instrument model number, serial number, voltage, and problem description available.

Problem	Causes and Solutions
The heater indicator LED stays red but the temperature does not increase	<p>The display does not show “Cut-out” nor displays an incorrect bath temperature, and the controller otherwise appears to operate normally. The problem may be insufficient heating, no heating at all, or too much cooling.</p> <ul style="list-style-type: none"> <li>• The heater power setting being too low, especially at higher operating</li> <li>• One or more burned out heaters or blown heater fuses may also cause this problem. If the heaters seem to be burned out, contact an Authorized Service Center (see Authorized Service Centers in Chapter 1) for assistance.</li> </ul>
The controller display flashes “Cut-out” and the heater does not operate	<p>The display flashes “Cut-out” alternately with the process temperature.</p> <ul style="list-style-type: none"> <li>• If the process temperature displayed seems grossly in error, consult the following problem: ‘The display flashes “Cut-out” and an incorrect process temperature’.</li> <li>• Normally, the cutout disconnects power to the heater when the bath temperature exceeds the cutout set-point causing the temperature to drop back down to a safe value. If the cutout mode is set to “AUTO”, the heater switches back on when the temperature drops. If the mode is set to “RESET”, the heater only comes on again when the temperature is reduced and the cutout is manually reset by the operator, see Cutout in Chapter 10. Check that the cutout set-point is adjusted to 10 or 20°C above the maximum bath operating temperature and that the cutout mode is set as desired.</li> <li>• If the cutout activates when the bath temperature is well below the cutout set-point or the cutout does not reset when the bath temperature drops and it is manually reset, then the cutout circuitry or the cutout thermocouple sensor may be faulty or disconnected. Contact an Authorized Service Center (see Authorized Service Centers in Chapter 1) for assistance</li> </ul>
The display flashes “cutout” and an incorrect process temperature	<p>The problem may be that the controller’s voltmeter circuit is not functioning properly.</p> <ul style="list-style-type: none"> <li>• A problem could exist with the memory back-up battery. If the battery voltage is insufficient to maintain the memory, data may become scrambled causing problems. A nearby large static discharge may also affect data in memory. Verify that the parameters on the Report of Test. are accurate. Cycle the power off, disconnect the bath from AC, and then restart the bath.</li> </ul>

	<ul style="list-style-type: none"> <li>• If the problem reoccurs, the battery should be replaced. Contact an Authorized Service Center (see Authorized Service Centers in Chapter 1) for assistance.</li> <li>• If initializing the memory does not remedy the problem, there may be a failed electronic component. Contact an Authorized Service Center (see Authorized Service Centers in Chapter 1) for assistance.</li> <li>• The controller may need to be reset. Perform the following Factory Reset Sequence. <b>Factory Reset Sequence.</b> Hold the SET and EXIT buttons down at the same time while powering up the instrument. The instrument display shows '-init-', the model number, and the firmware version. Each of the controller parameters and calibration constants must be reprogrammed. The values can be found on the Report of Test that was shipped with the instrument.</li> </ul>
<p>The displayed process temperature is in error and the controller remains in the cooling or the heating state at any set-point value</p>	<p>Possible causes may be either a faulty control probe or erroneous data in memory.</p> <ul style="list-style-type: none"> <li>• The probe may be disconnected, burned out, or shorted. The probe is located inside the stirrer motor cover.</li> <li>• Check that the probe is connected properly. The probe may be checked with an ohmmeter to see if it is open or shorted. The probe is a platinum 4-wire Din 43760 type. The resistance should read 0.2 to 2.0 ohms between pins 1 and 2 on the probe connector and 0.2 to 2.0 ohms between pins 3 and 4. It should read 100 to 300 ohms between pins 1 and 4 depending on the temperature. If the probe appears to be defective, contact an Authorized Service Center (see Authorized Service Centers in Chapter 1) for assistance.</li> <li>• If the problem is not the probe, erroneous data in memory may be the cause. Re-initialize the memory as discussed in the problem 'The display flashes "cutout" and an incorrect process temperature'. If the problem remains, the cause may be a defective electronic component, contact an Authorized Service Center (see Authorized Service Centers in Chapter 1) for assistance.</li> </ul>
<p>The controller controls or attempts to control at an inaccurate temperature</p>	<p>The controller operates normally except when controlling at a specified set-point. At this set-point, the temperature displayed does not agree with the temperature measured by the user's reference thermometer to within the specified accuracy. This problem may be caused by an actual difference in temperature between the points where the control probe and thermometer probe measure temperature, by erroneous bath calibration parameters, or by a damaged control probe.</p> <ul style="list-style-type: none"> <li>• Check that the bath has an adequate amount of fluid in the tank and that the stirrer is operating properly.</li> <li>• Check that the thermometer probe and control probe are both fully inserted into the bath to minimize temperature gradient errors.</li> <li>• Check that the calibration parameters are all correct according to the Report of Test. If not, re-program the constants. The memory backup battery may be weak causing errors in data as described in the problem: 'The display flashes "cutout" and an incorrect process temperature'.</li> <li>• Check that the control probe has not been struck, bent, or damaged. If the cause of the problem remains unknown, contact an Authorized</li> </ul>

	Service Center (see Authorized Service Centers in Chapter 1) for assistance.
The controller does not maintain controller parameters or parameters are reset each time the power to the unit is removed	<p><b>Note:</b> Before performing the memory check, you need to record the controller calibration parameters (found in the CAL menu of the instrument) and any user-adjusted parameters that you have changed (such as the programmable set points and proportional band).</p> <p><b>Memory Check</b></p> <p>Doing a memory check is the easiest way to verify the ability of the battery to maintain controller parameters.</p> <ol style="list-style-type: none"> <li>1. Power off the instrument.</li> <li>2. Disconnect the instrument from AC power for 10 seconds.</li> <li>3. Reconnect the AC power and power on the instrument.</li> <li>4. If the display shows InIT and/or the cycle count shows a low number such as 0002, the battery is spent and should be replaced. Contact an Authorized Service Center for assistance.</li> <li>5. After replacing the battery, you must reprogram the calibration and user-adjustable parameters into the controller.</li> </ol>
The controller shows that the output power is steady but the process temperature is unstable	<p>Possible causes are an improper proportional band setting or the fluid being used.</p> <ul style="list-style-type: none"> <li>• If the bath temperature does not achieve the expected degree of stability when measured using a thermometer, try adjusting the proportional band to a narrower width as discussed in Proportional Band in Chapter 9.</li> <li>• Check to ensure the fluid has not deteriorated or is not too thick.</li> </ul>
The controller alternately heats for a while then cools	<p>The bath is not stable and the duty cycle is not constant.</p> <p>The proportional band being too narrow typically causes this oscillation. Increase the width of the proportional band until the temperature stabilizes as discussed in Proportional Band in Chapter 9.</p>
The controller erratically heats then cools, control is unstable	<p>If both the bath temperature and output power do not vary periodically but in a very erratic manner, the problem may be excess noise in the system. Noise due to the control sensor should be less than 0.001°C. However, if the probe has been damaged or has developed an intermittent short, erratic behavior may exist. The probe is located inside the stirrer motor cover.</p> <ul style="list-style-type: none"> <li>• Check for a damaged probe or poor connection between the probe and bath.</li> <li>• Intermittent shorts in the heater or controller electronic circuitry may also be a possible cause. Contact an Authorized Service Center (see Authorized Service Centers in Chapter 1) for assistance.</li> </ul>
The bath does not achieve low temperatures	<p>Too much heating or not enough cooling can cause this problem.</p> <ul style="list-style-type: none"> <li>• Check that the control indicator glows green showing that the controller is attempting to cool. The heaters may be disabled as a test by temporarily removing the heater fuses.</li> <li>• Insufficient cooling may be caused by lack of refrigerant. Contact an Authorized Service Center for assistance.</li> </ul>

## Comments

### EMC Directive

Fluke's equipment has been tested to meet the European Electromagnetic Compatibility Directive (EMCEMC Directive, 89/336/EEC). The Declaration of Conformity for your instrument lists the specific standards to which the unit was tested.

The instrument was designed specifically as a test and measuring device. Compliance to the EMC directive is through EN 61326-1:2006 *Electrical equipment for measurement, control and laboratory use – EMC requirements*.

This instrument was tested to Criteria A immunity requirements for Controlled EM Environments per EN61326-2-1:2006 for EM Field from 0.8-2.7 GHz.

As noted in the IEC 61326-1, the instrument can have varying configurations. The instrument was tested in a typical configuration with shielded RS-232 cables.

### Immunity Testing

The instrument was tested for laboratory locations. Criterion B was used for Radiated RF (IEC 61000-4-3) and Voltage dips, short interruptions, as well as voltage immunity tests (IEC 61000-4-11). Criterion C was used for Electrostatic Discharge (ESD, IEC 61000-4-2). If the instrument is subjected to ESD conditions, the instrument may require the user to cycle the power to return to normal operation.

### Emission Testing

The instrument fulfills the limit requirements for Class A equipment but does not fulfill the limit requirements for Class B equipment. The instrument was not designed to be used in domestic establishments.

### Low Voltage Directive (Safety)

In order to comply with the European Low Voltage Directive (73/23/EEC), Fluke equipment has been designed to meet the following standards:

- IEC 1010-1 (EN 61010-1)
- IEC 1010-2-010 (EN 61010-2-010)